

Laboratory & Industrial Ovens & Furnaces

LEADING HEAT TECHNOLOGY





Science for Solids

Materialography
Hardness Testing
Heat Treatment
Elemental Analysis
Milling & Sieving
Particle Analysis

As part of the VERDER Group, the business division VERDER SCIENTIFIC sets standards in the development, manufacture and sales of laboratory and analytical equipment. The instruments are used in the areas of quality control, research and development for sample preparation and analysis of solids.

www.verder-scientific.com

Leading Heat Technology

The Carbolite Gero brand is synonymous with high quality, leading heat technology in the design and manufacture of laboratory and industrial ovens and furnaces ranging from 30°C to 3000°C and sold globally to over 100 countries.

On 1st January 2016 Carbolite (UK) and Carbolite Gero (Germany) joined to become one company under the name of Carbolite Gero. With the combined product lines the company will strengthen its market position locally and globally. In the past, both companies gained strong, established reputations for engineering expertise in applied heating technology.

Carbolite Gero has two manufacturing and sales sites. One is based in Derbyshire, United Kingdom, where Carbolite has been manufacturing laboratory and industrial ovens and furnaces up to 1800°C since 1938; the second facility is located in Neuhausen, southern Germany, where high temperature furnaces up to 3000°C with a large variety of solutions for vacuum and other modified atmospheres have been manufactured since 1982.

In addition to the wide range of standard products as shown in this catalogue, Carbolite Gero is an expert in the development of customized equipment for complex heat treatment processes. Solving customers' individual application requirements has given Carbolite Gero an important place in aerospace, engineering, materials science, heat treatment, medical, bioscience and contract testing laboratories globally to name a few. Not only can Carbolite Gero supply products with Standards-compliant furnace and oven designs (eg, Nadcap heat treatment processes (AMS2750E)), but also fully traceable certification for control, measurement, recording and data acquisition devices, issued by an independent UKAS accredited laboratory.

All products, and more, featured in this catalogue are available through your local Carbolite Gero office or an extensive network of dealers and local sales organisations.

www.carbolite-gero.com



Laboratory & Industrial Ovens up to 700°C

Products in this section include both laboratory and industrial ovens with maximum operating temperatures up to 700°C.

	Model	up to	Page
Ovens Selection Guide			
			12
Laboratory Ovens			
Laboratory Bench Mounted Ovens	AX	250°C	13
Natural Convection Ovens	PN	300°C	14
Fan Convection Ovens	PF	300°C	15
High Temperature Bench Mounted Ovens	LHT	600°C	16
Industrial Ovens			
General Purpose Ovens	GP	300°C	17
Rapid Cooling Ovens	TLD	400°C	18
High Temperature Industrial Ovens	HT	600°C	19
Large General Purpose Ovens	LGP	700°C	20
Atmosphere Controlled Ovens			
High Temperature Modified Atmosphere Ovens	HTMA	700°C	22
Clean Room Ovens			
Clean Room Ovens	CR	250°C	23
High Temperature Clean Room Ovens	HTCR	600°C	24



Disclaimer

As Carbolite Gero has a policy of continuous product development, improvements and changes will be made during the lifetime of this catalogue. Carbolite Gero reserves the right to amend the specifications at any time and in any particular way without prior notice provided that the ultimate performance of the equipment is not reduced by such action.

If the dimensions or technical specification of a product in this catalogue are critical, it is important that Carbolite Gero is contacted to confirm the details prior to order placement.

Laboratory & Industrial Chamber Furnaces up to 1800°C

Products in this section include an extensive range of chamber furnace with maximum operating temperatures up to 1800°C. Application specific equipment includes the ranges of ashing and annealing furnaces.

	Model	up to	Page
Chamber Furnaces Selection Guide			
			28
Laboratory Chamber Furnaces			
Economy Chamber Furnaces	ELF	1100°C	29
Standard Chamber Furnaces	CWF	1300°C	30
Burn-off Chamber Furnaces	CWF-B	1200°C	30
Chamber Furnaces with Balance	CWF-BAL	1100°C	30
Rapid Heating Chamber Furnaces	RWF	1200°C	32
Top Loading Chamber Furnaces	VCF	1200°C	33
High Temperature Chamber Furnaces	RHF	1600°C	34
High Temperature Bottom Loading Furnaces	BLF	1800°C	36
High Temperature Laboratory Chamber Furnaces	HTF	1800°C	37
Industrial Chamber Furnaces			
High Temperature Industrial Chamber Furnaces	HTF	1800°C	38
General Purpose Chamber Furnaces	GPC	1300°C	39
NEW Modified Atmosphere Chamber Furnaces	GPCMA	1200°C	40
Large Chamber Furnaces	LCF	1400°C	42
Top Hat Furnaces	HB	1800°C	43
Static or Bogie Hearth Chamber Furnaces	SBCF	1100°C	44
Annealing Furnaces			
Air Recirculating Furnaces	HRF	750°C	45
Annealing Furnaces	GLO	1100°C	46
Ashing Furnaces Selection Guide			
			48
Ashing Furnaces			
Standard Ashing Furnaces	AAF	1200°C	49
Ashing Furnace with Balance	AAF-BAL	1100°C	51
Specialist Ashing Furnaces	GSM	1100°C	52
Afterburner Ashing Furnaces	ABF	800°C	53



Horizontal & Vertical Tube Furnaces up to 2600 °C

Products in this section include an extensive range of tube furnaces with maximum operating temperatures up to 2600 °C. The range of tube furnaces includes horizontal and vertical, single and 3-zone models as well as models specifically for use under vacuum.

	Model	up to	Page
Tube Furnaces Selection Guide			
Universal Tube Furnaces			
Small Tube Furnaces	MTF	1200 °C	58
Large Tube Furnaces	CTF, TZF	1200 °C	59
Compact Tube Furnaces	E range	1200 °C	60
Modular Horizontal and Vertical Tube Furnaces	G range	1200 °C	62
Horizontal and Vertical Tube Furnaces	F range	1350 °C	64
High Temperature Tube Furnaces	STF, TZF	1600 °C	66
High Temperature Horizontal Tube Furnaces	HTRH	1800 °C	68
High Temperature Vertical Tube Furnaces	HTRV	1800 °C	70
Graphite Tube Furnaces	HTRH-GR	2600 °C	72
Split Tube Furnaces			
Compact Split Tube Furnaces	E range	1200 °C	74
Horizontal Split Tube Furnaces	HST, HZS	1200 °C	76
Vertical Split Tube Furnaces	VST, TVS	1200 °C	78
Large Horizontal and Vertical Split Tube Furnaces	K range	1200 °C	80
Horizontal and Vertical Split Tube Furnaces	F range	1300 °C	82
High Temperature Vertical Split Tube Furnaces	HTRV-A	1700 °C	84
Rotary Reactor Tube Furnaces	HTR	1100 °C	86
Rotating Horizontal Split Tube Furnaces	RHZZ, RHST	1150 °C	87
Gradient Tube Furnaces			
NEW 8-Zone Tube Furnaces	AZ	1350 °C	89
NEW Compact Gradient Split Tube Furnace	HZS-2G, EZS-3G	1200 °C	90



Application Specific Furnaces

Products in this section introduce Carbolite Gero's range of application specific furnaces with maximum operating temperatures up to 1800 °C. Also included in this section is an introduction to Carbolite Gero furnaces up to 3000 °C and Carbolite Gero's custom designed ovens and furnaces up to 1800 °C.

	Model	up to	Page
Application Specific Furnaces			
Coal and Coke Test Equipment			94
Asphalt Binder Analyser	ABA	750 °C	96
Thermocouple Calibration Furnaces	PTC	1200 °C	97
Carbon-14 and Tritium Furnaces	MTT	1200 °C	98
Dental Furnaces	CDF	1530 °C	99
Cupellation Furnaces	CF	1200 °C	100
Smelting Furnaces	SCF	1350 °C	101
Vacuum, Inert and Reactive Gas Furnaces		3000 °C	102
Custom Designed Ovens & Furnaces		1800 °C	103

Product Configurations

All Carbolite Gero products are fitted with a controller from a sophisticated range of temperature controllers and optional data loggers. Tube furnaces often require additional work tubes and accessories for use with modified atmosphere and vacuum. Chamber furnaces can also be used with modified atmosphere by fitting a retort. Detailed information on these options as well as power supply information can be found on the following pages.

Product Configurations	
Temperature Control Options	106
Work Tube Selection Guide	112
Work Tube Packages	114
Work Tube Accessories	116
Vacuum Pump Packages for Tube Furnaces	118
Retort Options for CWF and GPC Furnaces	119
Modified Atmosphere Options	120

Power Supply Information	122
---------------------------------	-----

Index	126
--------------	-----

CGH Manufactured at Carbolite Gero Hope

CGN Manufactured at Carbolite Gero Neuhausen

Temperature

Temperature is a measure of the heat or kinetic energy of the particles within a substance.

There are three primary mechanisms of heat transfer: convection, conduction and radiation. All three mechanisms occur within Carbolite Gero products.

In **convection** heat transfer occurs by the movement of gases or liquids. The movement occurs within a fluid or gas by the tendency of hotter, and therefore less dense, material to rise, and colder denser material to sink under the influence of gravity. This results in transfer of heat. Most Carbolite Gero products contain an atmosphere of air or another gas and heat will be transferred within the atmosphere by convection. The graph shows that convection is the dominant heat transfer mechanism below 700°C. Carbolite Gero ovens work in the temperature range up to 700°C and often use fans to mix the atmosphere to improve the temperature uniformity within the working chamber.

Conduction is the process by which heat is directly transmitted through the material of a substance when there is a difference of temperature between adjoining regions. Different materials have different heat conductance which is a measure of their heat conduction. Carbolite Gero often uses thermal insulation material with extremely low heat conductance to contain heat within the working chamber.

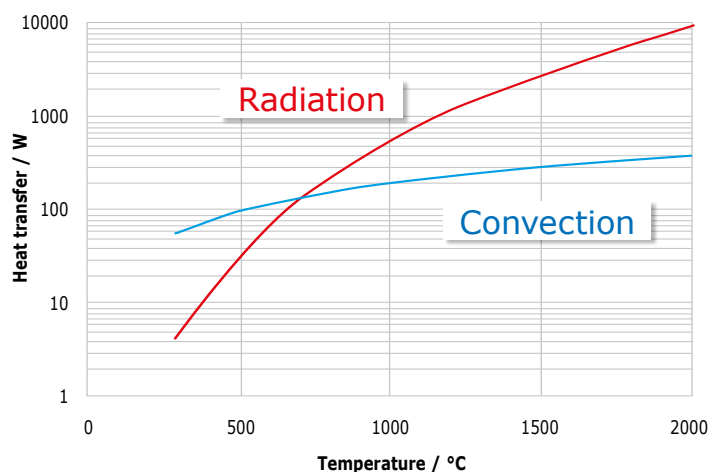

Radiation is the emission of energy as electromagnetic waves. Radiation can pass through a gas atmosphere or a vacuum, but not through a solid. From the graph we can see that radiation is the dominant heat transfer mechanism above 700°C. Carbolite Gero furnaces are designed for radiant heat transfer where chamber design, location of heating elements and use of thermal insulation techniques are critical for superior performance. Because radiation cannot pass through a solid Carbolite Gero utilises radiation shields as a thermal insulation technique. An example of this is the application of radiation shields in a tube furnace, or the radiation shield in a Carbolite Gero metallic vacuum furnace.



Atmosphere

A critical factor in the use of Carbolite Gero products is the determination of the atmosphere required for a heat treatment process. The table below provides an overview of product type, its heating element material and the type of atmospheres or vacuum in relation to the temperature range. For gas tight ovens below 700°C modified atmospheres are available but vacuum is not possible.

Chamber furnaces up to 1800°C are not gas tight so the control of the atmosphere is limited and vacuum is not possible. In these products gas tight retorts are required to achieve modified atmosphere such as oxygen, nitrogen, argon, hydrogen or formation gas up to 1100°C (see page 119). Tube furnaces can be used with work tube packages to provide vacuum up to 1500°C and modified atmospheres up to 1800°C.

Heating methods (may need further equipment)	Temperature ranges and their related atmospheres and vacuum ability				
	30°C - 700°C	up to 1100°C	up to 1300°C	up to 1600°C	up to 1800°C
Ovens with convection heating (CrFeAl)	Air and modified atmosphere, No vacuum available				
Chamber furnaces with inconel retort (CrFeAl)	Air and modified atmosphere, No vacuum available				
Chamber furnaces (CrFeAl)	Air and limited modified atmosphere, No vacuum available				
Chamber furnaces (SiC)	Air and limited modified atmosphere, No vacuum available				
Chamber furnaces (MoSi ₂)	Air and limited modified atmosphere, No vacuum available				
Tube furnaces (CrFeAl)	Air, modified atmosphere and vacuum				
Tube furnaces (SiC)	Air and modified atmosphere up 1600°C, vacuum limited to 1500°C				
Tube furnaces (MoSi ₂)	Air and modified atmosphere up 1800°C, vacuum limited to 1500°C				

Application matrix

-  specially suited for
-  limited suitability
- not suited for
- * requires additional option











































Application																	
Ashing/calcination/ LOI/burn-off	Sintering	Pyrolysis	Transport reactions (including CVD)	Hardening / tempering	Melting	Materials testing	Tensile testing	Thermocouple calibration	Annealing / stress relieving	Drying / moisture extraction*	Stoving & curing*	Clean room applications	Precious metals applications	Coal assay including ash fusibility	Asphalt binder analysis	Dental	Carbon -14 & tritium

Ovens (see pages 12–25)





























































Models

up to 600 °C	AX, PN, PF GP, LGP, LHT, HT, HTMA				-		-	-				-	-	-	-	-	-
	CR, HPCR	-	-	-	-		-	-			-		-	-	-	-	-
	TLD	-	-	-		-		-	-			-	-	-	-	-	-

















Chamber Furnaces (see pages 28–53)

up to 1300 °C	ELF			-	-		-	-		-	-	-	-	-	-	-	-	
	HRF	-		-	-		-	-			-	-	-	-	-	-	-	
	CFW, RWF, GPC, LCF, SBCF				-				-	-		-	-	-	-	-	-	-
	GLO	-		-	-		-	-		-	-	-	-	-	-	-	-	
	AAF, AAF-BAL, CWF-B, CWF-BAL, GSM, ABF				-		-		-	-		-	-	-	-	-	-	-
	VCF				-	-			-	-		-	-	-	-	-	-	-
up to 1400 °C - 1800 °C	RHF, HTF			-	-			-	-			-	-	-	-	-	-	
up to 1300 °C - 1800 °C Bottom loading/top hat furnaces	BLF, HB				-			-	-		-	-	-	-	-	-	-	

Tube Furnaces (see pages 56–91)

up to 1350 °C Single zone	MTF, CTF, EHA, EST, EVA, EVT, FHA, FST, GHA, GVA, VST, HST, KST, KVT									-	-	-	-	-	-	-	-
up to 1350 °C 3-zone	TZF, EHC, EVC, EVZ, EZS, FHC, FZS, GHC, GVC, HZS, KVZ, KZS, TVS									-	-	-	-	-	-	-	-
up to 1350 °C 8-zone gradient	AZ									-	-	-	-	-	-	-	-
up to 1400 °C - 1600 °C Single zone	STF					-				-	-	-	-	-	-	-	-
up to 1400 °C - 1600 °C 3-zone	TZF					-				-	-	-	-	-	-	-	-
up to 1700 °C - 1800 °C Single zone	HTRH, HTRV, HTRV-A					-				-	-	-	-	-	-	-	-
up to 1700 °C - 1800 °C 3-zone	HTRH-3					-				-	-	-	-	-	-	-	-
up to 1100 °C - 1200 °C Single zone rotating tube furnace	HTR, RHST				-	-		-	-	-	-	-	-	-	-	-	-
up to 1100 °C - 1200 °C 3-zone rotating tube furnace	RHZS				-	-		-	-	-	-	-	-	-	-	-	-

Application Specific Furnaces (see pages 94-101)

	CAF G5	-	-	-	-	-	-	-	-	-	-	-	-	-		-	-	
	ABA		-	-	-	-		-	-	-	-	-	-	-	-		-	-
	CDF			-	-	-		-	-	-	-	-	-	-	-		-	-
	CF, SCF		-	-	-	-	-	-	-	-	-	-		-	-	-	-	-
	MTT					-	-		-	-	-	-	-	-	-	-	-	
	PTC	-	-	-	-	-	-	-		-	-	-	-	-	-	-	-	-

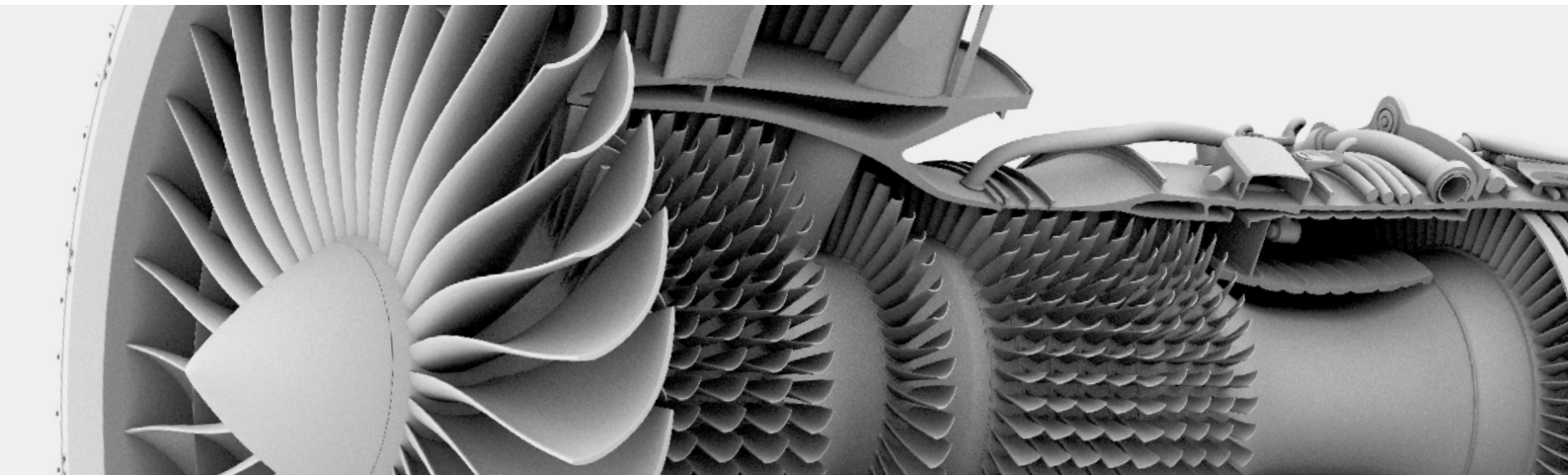

Carbolite Gero's expertise in pyrometry and the application of AMS2750E

Created by the Performance Review Institute, the Nadcap programme is designed to provide an accreditation and quality assurance framework for a defined range of 'special processes and products' that are used within the Aerospace and Defence sectors. It was originally sponsored by Boeing and is now adopted by all Western aerospace manufacturers.

Nadcap is becoming increasingly important in the aerospace sector with accreditation frequently being requested by companies such as: GE Aviation, Rolls Royce plc, MTU, Snecma, Turbomeca, Boeing, Vought Aircraft Industries, Bombardier, Honeywell,

Hamilton Sundstrand and Sikorsky Aircraft.

Manufacturers and end users must follow the requirements of the SAE Aerospace Standard Number AMS2750E. In this Standard ovens and furnaces are classified by their temperature uniformity and the type of control instrumentation that they use.

Carbolite Gero has significant expertise in supplying aerospace customers with ovens and furnaces designed for full Nadcap compliance.

Some examples are shown on the following pages identified by this AMS icon.



What is Nadcap?

National Aerospace and Defence Contractors Accreditation Programme

A quality system for aerospace manufacturers and subcontractors controlled through audited standards.

Other standards aligned within Nadcap

- Aerospace Standard AS7102 Ref A
- Audit Control AC 7102 Rev B
- Rolls Royce standard RPS 953 issue 12

For product to conform with AMS2750E the following have to be defined:

1. **Temperature range of compliance**
2. **Class of temperature uniformity required – either Class 1, 2, 3, 4, 5 or 6**
3. **Temperature Instrumentation type – either Type A, B, C, D or E – see diagram on the next page**
4. **Uniform zone required – define H x W x D**
5. **Temperature Uniformity Survey (TUS) required either with charge or empty chamber**
6. **System Accuracy Test (SAT) requirements**

Class	Uniformity
1	±3°C
2	±6°C
3	±8°C
4	±10°C
5	±14°C
6	±28°C

For class 1 uniformity, ±3°C, the size of an oven chamber needs to be significantly larger than the working volume. If a working volume of 600 mm x 600 mm x 600 mm is required we recommend a chamber volume of at least 800 mm x 800 mm x 800 mm.

Product instrumentation 'Type'

Control instrumentation type is defined as Type A, B, C, D or E. The differences between these types are shown in the diagram below and relate to the number of recording thermocouples permanently installed in the work-space and the instrumentation used to monitor these.

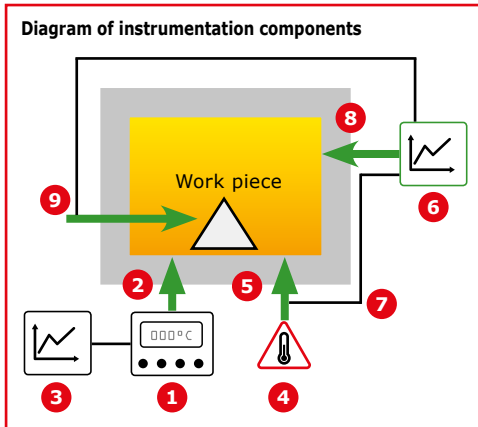

Instrumentation components		Type A	Type B	Type C	Type D	Type E
1	Control instrument with temperature display	X	X	X	X	X
2	Control sensor	X	X	X	X	X
3	Control instrument recorder	X	X	X	X	
4	Over-temperature protection instrument	X	X	X	X	
5	Over-temperature protection sensor	X	X	X	X	
6	Multipoint chart recorder (or separate channel in control instrument recorder)	X	X	X		
7	High temperature protection sensor connected to multipoint recorder	X		X		
8	Low temperature sensor connected to multipoint recorder	X		X		
9	Load sensor connected to multipoint recorder	X	X			

Examples of products built to comply with AMS2750E

Model	Page	Max temp. (°C)	Temp. uniformity ± (°C)	AMS2750E uniformity class	AMS2750E instrument. type
PF800	15	250	5	2	D
PF200	15	300	5	2	D
PF60	15	300	5	2	B
PF200	15	250	5	2	D
GP450A	17	300	10	4	D
GP450A	17	300	5	2	D
GP220B	17	250	6	2	B
LGP2/935	20	250	6	2	C
LGP2/1212	20	250	6	2	A
LGP2/1750	20	250	5	2	C
LGP4/1419	20	425	6	2	A
LGP6/1180 S&C	20	625	10	4	B
LGP6/1750	20	625	5	2	C
LGP6/2700	20	625	6	2	D
HT4/220	19	400	6	2	D
HT5/95	19	500	14	5	B
HT5/350	19	500	6	2	C
HT6/220	19	600	6	2	A
HRF 7/45B	45	750	6	2	D
HRF 7/45	45	750	5	2	D
CWF 12/36	30	1200	10	4	D
CWF 13/65	30	1300	6	2	D
GPC 12/131	39	750	5	2	D
LCF 14/350	42	1400	8	3	D
LCF 12/560	42	1200	6	2	B

AMS2750E uniformity data for the LGP oven range

Model size	Uniform Volume [mm]			
	CLASS 1 (±3°C)	CLASS 2 (±6°C)	CLASS 3 (±8°C)	CLASS 4 (±10°C)
500	500x500x500	600x600x600	625x625x625	650x650x650
730	600x600x600	700x700x700	725x725x725	750x750x750
1000	700x700x700	750x750x750	825x825x825	850x850x850
1500	1200x700x700	1250x750x750	1300x825x825	1300x850x850
1750	900x900x900	950x950x950	1025x1025x1025	1050x1050x1050
2160	1200x900x900	1250x950x950	1325x1025x1025	1350x1050x1050
3370	1100x1100x1100	1200x1200x1200	1225x1225x1225	1250x1250x1250

LGP 2: Operate at a maximum temperature of 250°C
Temperature Spread:
CLASS 1: 150°C - 250°C one temp only between this range
CLASS 2, 3 & 4: 150°C - 250°C -> Two points between this range

LGP 4: Operate at a maximum temperature of 425°C
Temperature Spread:
CLASS 1: 250°C - 425°C one temp only between this range
CLASS 2, 3 & 4: 250°C - 425°C -> Two points between this range

LGP 6: Operate at a maximum temperature of 625°C
Temperature Spread:
CLASS 1: 425°C - 625°C one temp only between this range
CLASS 2, 3 & 4: 425°C - 625°C -> Two points between this range

Laboratory & Industrial Ovens up to 700 °C

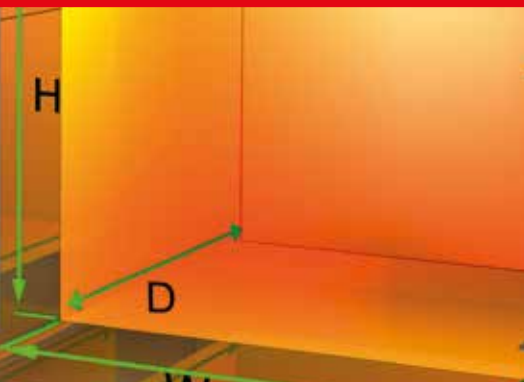

Ovens	Models	Page
Ovens Selection Guide		12
Laboratory Ovens	AX, PN, PF, LHT	13
Industrial Ovens	GP, TLD, HT, LGP	17
Atmosphere Controlled Ovens	HTMA	22
Clean Room Ovens	CR, HPCR	23

As discussed in the Physics of Heat (page 6) Carbolite Gero defines ovens as operating up to 700°C, where heat transfer is predominantly by convection (as shown right).

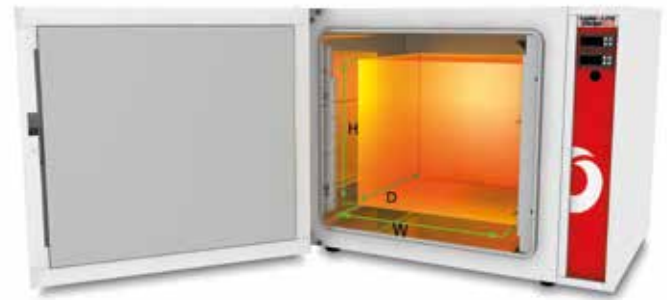

Carbolite Gero's design features optimised uniform volume

Factors to consider when selecting an oven:

What temperature?

- Carbolite Gero offers several ranges of ovens with different maximum operating temperatures from maximum temperatures of 250°C to as high as 700°C with minimum working temperatures of ambient +30°C to +60°C
- Ovens are suitable for use at their maximum operating temperature.

What size?

- Carbolite Gero's smallest bench mounted oven has a capacity of 30 litres, but larger standard volume ovens up to 14,000 litres are available.
- The uniform volume of an oven is smaller than the total volume due to the heat losses through the walls and door.

Natural or fan convection?

- Simple ovens do not have a fan fitted, but have elements mounted in the chamber base. Air circulates by convection; the warmed air at the base initially rises then falls as it cools. The resulting slow airflow is preferable, for example, for processes involving powders which may be disturbed by fan convection or where there is a risk of cross contamination between samples.

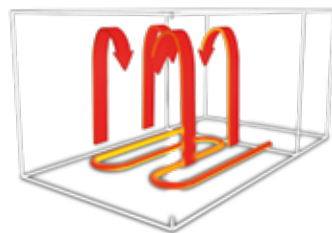

- In fan convection ovens the elements are located on the side of the oven and on smaller ovens the fan blows air through an air-guide, over the heating elements and around the chamber. On larger ovens, where there is room for a more complex air guide, the fan pulls air over the elements. The fan action thoroughly mixes the heated air, equalising its temperature before blowing it around the chamber and over the sample. This provides a uniform volume within the oven chamber for applications that require a specific temperature uniformity (the image top right shows a typical optimised uniform zone h x w x d).

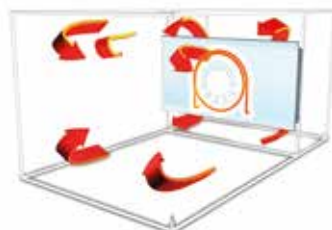

Advantages of fan convection

- Ovens heat up and recover the temperature more quickly
- The higher airflow improves the contact between the sample/load and as a result the sample/load also heats up faster
- The airflow conveys the heat to the temperature sensor more quickly, resulting in improved control stability
- The temperature uniformity is improved
- The fan promotes higher airflow in and out of the chamber and speeds up drying by faster removal of vapour (water or solvents – see additional note regarding the use of solvents in ovens)
- Variable speed fans are also offered which can be a solution to the problem of disturbing the samples/ cross contamination

Exhaust options

Exhaust fan – an extraction unit is fitted to the oven and is provided with an on/off switch. Suitable for use in applications creating large amounts of fumes which need to be extracted from the oven.

Moisture extraction (MEO) – this option makes the oven suitable for drying processes which contain a lot of moisture. It includes the air exhaust fan option, plus the addition of sealing the chamber seams to prevent moisture from entering the insulation.

Stoving and curing – designed for use with paints, resins and solvents, this option can remove small quantities of volatile solvents from the chamber. It includes the air exhaust fan and sealing of the chamber seams. An airflow failure sensor cuts heating if the exhaust system is not working effectively. An explosion relief panel is also added: a section of the chamber lining and the outer case are replaced with a lightweight thermal insulation panel which is covered with aluminium foil; in the event of an explosion this panel is harmlessly pushed out of the oven to release the pressure. Electronic over-temperature protection is fitted as standard with this option. The fitting of the stoving and curing option enables ovens to meet the requirements of BS EN 1539 : 2015 'Dryers and ovens, in which flammable substances are released – safety requirements'.

NOTE: This option is suitable for small amounts of solvent only – please consult Carbolite Gero regarding your application before ordering this option.



AX – Laboratory Bench Mounted Ovens

The Apex AX range of 250°C laboratory ovens, comprises three bench mounted models equipped with the R38 digital PID temperature controller.



AX 60

AX 30

Standard features

- 250°C maximum operating temperature
- Equipped with the R38 digital PID temperature controller as standard
- 30, 60 or 120 litre chamber volumes
- Fan convection for rapid heating & excellent uniformity
- Chemically resistant stainless steel liner
- Two adjustable nickel-chrome plated wire shelves
- Lever latch door & airtight silicone seal
- Built to comply with BS EN 61010-2-010:2003

Options (specify these at time of order)

- Over-temperature protection (recommended to protect valuable contents & for unattended operation)
- Digital countdown timer to switch oven off
- Additional sets of shelves & runners
- Lockable door
- Low voltage options for use below 220 V
- Routine spares kit
- **NEW** Oven stacking frame

Technical data

CGH Model	Max. temp. [°C]	Temperature uniformity [°C]	Heat-up time [mins]	Recovery time [mins]	Dimensions: Internal H x W x D [mm]	Dimensions: External H x W x D [mm]	Shelves fitted / accepted	Shelf loading each / total [kg]	Volume [litres]	Air changes / hr	Max. power [W]	Holding power [W]	Weight [kg]
AX 30	250	±5.0 @ 250°C	23	3	295 x 300 x 320	440 x 590 x 465	2 / 4	10 / 20	28	65	1000	342	24
AX 60	250	±5.0 @ 250°C	25	3	395 x 400 x 420	540 x 690 x 565	2 / 6	10 / 30	66	28	1500	465	37
AX 120	250	±5.0 @ 250°C	26	3	495 x 500 x 520	640 x 790 x 665	2 / 8	10 / 40	128	14	2000	622	55

i Please note:

- Minimum operating temperature approximately ambient plus 30°C
- Uniformity is measured in an empty chamber with vents closed, after a stabilisation period
- Maximum power and heat up time based on a 240 V supply
- Shelf loadings are based on evenly distributed weight
- External dimensions with door closed
- The uniform volume is smaller than the total chamber volume



PN – Natural Convection Ovens

The Peak range 300°C laboratory ovens are available in both PN natural convection and in the PF fan convection models. All PN models are bench mounted.

In the PN ovens air circulation depends upon natural convection. The resulting slow airflow is preferable, for example, for processes involving powders which may be disturbed by fan convection or where there is a risk of cross contamination between samples.

The reduced complexity makes natural convection a less expensive option.

Standard features

- 300 °C maximum operating temperature
- R38 PID controller (see below for other controller options)
- Economical natural convection models
- Chemically resistant stainless steel liner
- Two nickel-chrome plated wire shelves
- Lever latch door & airtight silicone seal
- Compliant with safety standard BS EN 61010-2-010:2003



PN 60 with 301 controller option

Options (specify these at time of order)

- A range of sophisticated digital controllers, multi-segment programmers and data loggers is available. These can be fitted with RS232, RS485 or Ethernet communications (see pages 106 – 111)
- Over-temperature protection (recommended to protect valuable contents & for unattended operation)
- Access port for independent thermocouple
- Accessory shelves & runners
- Cable access ports
- Viewing window
- Interior light
- Stacking frame
- Lockable door
- Door interlock activated by temperature alarm relay (3216, CC-T1, 3508 or nanodac) or program segment output (CC-T1, 3508 or nanodac)
- Door switch to isolate elements
- Floor stands & wheeled trolleys
- Routine spares kit

NEW Heavy duty options

Model	Reinforced base	Heavy duty shelves	
	Max. weight [kg]	Max. quantity	Max. weight / shelf [kg]
PN 30	40	2	20
PN 60	60	3	20
PN 120	80	3	25
PN 200	100	4	25

Please note: Reinforced base, shelf runners and shelves supplied as a package

Technical data

Model	Max. temp. [°C]	Temp. stability [°C]	Temperature uniformity [°C]	Heat-up time [mins]	Recovery time [mins]	Dimensions: Internal H x W x D [mm]	Dimensions: External H x W x D [mm]	Shelves fitted / accepted	Shelf loading each / total [kg]	Volume [litres]	Max. power [W]	Holding power [W]	Weight [kg]
PN 30	300	±0.5	±7.0 @ 300°C	52	8.5	255 x 330 x 320	470 x 665 x 470	2 / 3	10 / 20	27	750	300	37
PN 60	300	±0.5	±7.0 @ 300°C	52	8.5	350 x 392 x 420	570 x 765 x 570	2 / 5	10 / 30	57	1000	480	55
PN 120	300	±0.5	±7.0 @ 300°C	52	8.5	450 x 492 x 520	670 x 865 x 670	2 / 9	10 / 40	115	1500	720	74
PN 200	300	±0.5	±7.0 @ 300°C	58	10	700 x 592 x 520	920 x 965 x 670	2 / 15	10 / 50	215	2250	1160	96

Please note:

- Minimum operating temperature approximately ambient plus 30°C
- Uniformity is measured in an empty chamber with vents closed, after a stabilisation period
- Maximum power and heat up time based on a 240 V supply

- Shelf loadings are based on evenly distributed weight
- External dimensions with door closed
- Temperature uniformity is smaller than the total chamber volume



PF – Fan Convection Ovens

The Peak range 300 °C laboratory ovens are available as both PF fan convection and PN natural convection models.

Fan convection provides greater temperature uniformity and faster recovery rates than natural convection.

Standard features

- 300 °C (PF 30 to PF 200) or 250 °C (PF 400, PF 800) maximum operating temperatures
- R38 PID controller (see below for other controller options)
- 28 to 910 litre chamber volumes
- Fan convection for rapid heating & recovery & excellent uniformity
- Chemically resistant stainless steel liner
- Two nickel-chrome plated wire shelves (The PF 400 is supplied with 3 wire shelves, the PF 800 with 3 perforated stainless steel shelves)
- Lever latch door & airtight silicone seal
- Compliant with safety standard BS EN 61010-2-010:2003



PF 60 with 301 controller and optional exhaust fan and over-temperature control

Options (specify these at time of order)

- A range of sophisticated digital controllers, multi-segment programmers and data loggers is available. These can be fitted with RS232, RS485 or Ethernet communications (see pages 106 – 111)
- Over-temperature protection (recommended to protect valuable contents & for unattended operation)
- Access port for independent thermocouple
- Cable entry port
- Variable speed fan control
- Stoving & curing for extraction of small volumes of volatile solvents (not compatible with viewing window option)
- Viewing window (not compatible with stoving & curing option)
- Interior light (not compatible with stoving & curing option)
- Air exhaust fan
- Moisture extraction option (comprising sealed seams and air exhaust fan)
- Lockable door
- Door interlock activated by temperature alarm relay (3216, CC-T1, 3508 or nanodac) or program segment output (CC-T1, 3508 or nanodac)
- Door switch to isolate elements and fan

NEW Heavy duty options

Model	Reinforced base	Heavy duty shelves	
	Max. weight [kg]	Max. quantity	Max. weight / shelf [kg]
PF 30	40	2	20
PF 60	60	3	20
PF 120	80	3	25
PF 200	100	4	25
PF 400	150	5	25
PF 800	225	5	75

Please note: Reinforced base, shelf runners and shelves supplied as a package

Technical data

Model	Max. temp. [°C]	Temp. stability [°C]	Temp. uniformity [°C]	Heat-up time [mins]	Recovery time [mins]	Dimensions: Internal H x W x D [mm]	Dimensions: External H x W x D [mm]	Shelves fitted / accepted	Shelf loading each / total [kg]	Volume [litres]	Air changes / hr	Max. power [W]	Holding power [W]	Weight [kg]
PF 30	300	±0.2	±5.0 @ 300°C	40	4	300 x 290 x 320	470 x 665 x 470 (Bench-top)	2 / 3	10 / 20	28	50 / 312*	1000	560	37
PF 60	300	±0.2	±5.0 @ 300°C	36	4	400 x 390 x 420	570 x 765 x 570 (Bench-top)	2 / 5	10 / 30	66	21 / 137*	1500	775	55
PF 120	300	±0.2	±5.0 @ 300°C	35	4	500 x 490 x 520	670 x 865 x 670 (Bench-top)	2 / 9	10 / 40	127	11 / 72*	2000	900	74
PF 200	300	±0.2	±5.0 @ 300°C	42	5	750 x 590 x 520	920 x 965 x 670 (Bench-top)	2 / 15	10 / 50	230	6 / 40*	2700	1180	96
PF 400	250	±0.2	±5.0 @ 250°C	85	25	1500 x 605 x 510	1835 x 1025 x 1100 (Floor-standing)	3 / 14	10 / 75	460	66*	6000	2200	200
PF 800	250	±0.2	±5.0 @ 250°C	100	30	1500 x 1200 x 510	1835 x 1615 x 1100 (Floor-standing)	3 / 7	10 / 100	910	33*	9000	3500	280

i Please note:

- Minimum operating temperature approximately ambient plus 30 °C
- Uniformity is measured in an empty chamber with vents closed, after a stabilisation period
- Maximum power and heat up time based on a 240 V supply
- Stoving and curing option may require increased maximum power

- External dimensions with door closed
- The uniform volume is smaller than the total chamber volume
- Shelf loadings are based on evenly distributed weight
- * When equipped with optional exhaust fan



LHT – High Temperature Bench Mounted Ovens

The LHT laboratory high temperature ovens comprise three sizes of bench mounted ovens, each available with maximum operating temperatures of 400°C, 500°C and 600°C.

Standard features

- 400°C, 500°C or 600°C operating temperatures
- R38 PID controller (see below for other controller options)
- 30, 60 & 120 litre capacities
- Heavy duty convection fan for good uniformity
- Low thermal mass insulation for fast response & energy efficiency
- Corrosion resistant, brushed stainless steel interior
- 2 Multi-position shelves
- Suitable for continuous operation
- Hard wearing, zinc coated & stoved epoxy polyester coated exterior



LHT 6/30 with 301 controller option

Options (specify these at time of order)

- A range of sophisticated digital controllers, multi-segment programmers and data loggers is available. These can be fitted with RS232, RS485 or Ethernet communications (see pages 106 – 111)
- Over-temperature protection (recommended to protect valuable contents & for unattended operation)
- Viewing window
- Cable entry port
- Variable speed fan
- Floor stands & stacking frame with vent
- Routine spares kit
- Air exhaust fan (may alter achievable uniformity)
- Door interlock activated by temperature alarm relay (3216, CC-T1, 3508 or nanodac) or program segment output (CC-T1, 3508 or nanodac)

NEW Heavy duty options

Model	Reinforced base	Heavy duty shelves	
	Max. weight [kg]	Max. quantity	Max. weight / shelf [kg]
LHT 30	40	2	20
LHT 60	60	3	20
LHT 120	80	3	25

Please note: Reinforced base, shelf runners and shelves supplied as a package

Technical data

CGH	Max. temp. [°C]	Temp. stability [°C]	Temperature uniformity [°C]	Heat-up time [mins]	Recovery time [mins]	Dimensions: Internal H x W x D [mm]	Dimensions: External H x W x D [mm]	Shelves fitted / accepted	Shelf loading each / total [kg]	Volume [litres]	Max. power [W]	Weight [kg]
LHT 4/30	400	±0.5	±5.0 @ 250°C	50	10	300 x 300 x 305	570 x 860 x 550	2	10 / 20	30	1000	73
LHT 4/60	400	±0.5	±5.0 @ 250°C	-	16	400 x 400 x 405	670 x 930 x 670	2 / 3	15 / 30	60	1500	99
LHT 4/120	400	±0.5	±5.0 @ 250°C	-	20	645 x 455 x 405	920 x 1060 x 670	2 / 4	15 / 40	120	2250	137
LHT 5/30	500	±0.5	±5.0 @ 250°C	-	10	300 x 300 x 305	570 x 860 x 550	2	10 / 20	30	2000	73
LHT 5/60	500	±0.5	±5.0 @ 250°C	50	16	400 x 400 x 405	670 x 930 x 670	2 / 3	15 / 30	60	2250	99
LHT 5/120	500	±0.5	±5.0 @ 250°C	-	20	645 x 455 x 405	920 x 1060 x 670	2 / 4	15 / 40	120	3000	137
LHT 6/30	600	±0.5	±5.0 @ 250°C	70	10	300 x 300 x 305	570 x 860 x 550	2	10 / 20	30	2000	73
LHT 6/60	600	±0.5	±5.0 @ 250°C	-	10*	400 x 400 x 405	670 x 930 x 670	2 / 3	15 / 30	60	2250	99
LHT 6/120	600	±0.5	±5.0 @ 250°C	-	-	645 x 455 x 405	920 x 1060 x 670	2 / 4	15 / 40	120	3000	137

ⓘ Please note:

- Minimum operating temperature approximately ambient plus 60°C

*Recovery to 500°C setpoint

- External dimensions with door closed

- The uniform volume is smaller than the total chamber volume

- Maximum power and heat up time based on a 240 V supply



GP – General Purpose Ovens

The GP general purpose 300°C industrial ovens are supplied in three sizes and two configurations: vertical (A) and horizontal (B) airflow.

This range also provides a foundation upon which a wide range of custom modifications can be added. Typical examples of which are the more sophisticated control systems and data recording that is required for applications such as AMS2750E heat treatment under Nadcap, or modifications to handle heavier loads or assist in loading and unloading the oven, or simply larger chamber sizes than are offered in the standard range.

Standard features

- 300°C maximum operating temperature
- Carbolite Gero 301 controller with single ramp to setpoint facility
- 430 grade ferritic stainless steel internal case
- Robust external construction from steel section & zinc coated mild steel panels
- Mineral insulated metal sheathed heating elements
- Adjustable chamber ventilation

NEW Heavy duty options

Model	Reinforced base	Heavy duty shelves	
	Max. weight [kg]	Max. quantity	Max. weight / shelf [kg]
GP 220A	150	3	50
GP 330A	200	4	50
GP 450A	250	5	50
GP 220B	150	3	50
GP 330B	225	3	75
GP 450B	225	3	75

Please note: Reinforced base, shelf runners and shelves supplied as a package



GP 450A with 3216P1 programmer option and over-temperature protection, plus AMS2750E thermocouple connection loops

GP 330B with 3508P1 programmer and exhaust fan option

Options (specify these at time of order)

- A range of sophisticated digital controllers, multi-segment programmers and data loggers is available. These can be fitted with RS232, RS485 or Ethernet communications (see pages 106–111)
- Over-temperature protection (recommended to protect valuable contents & for unattended operation)
- Port for independent thermocouple
- Cable access ports
- Bespoke models are available for AMS2750E (Nadcap) compliant applications
- Additional shelves
- Door interlock activated by temperature alarm relay (3216, CC-T1, 3508 or nanodac) or program segment output (CC-T1, 3508 or nanodac)
- Stoving & curing for extraction of small volumes of volatile solvents (not compatible with viewing window option)
- Viewing window (not compatible with stoving & curing option)
- Interior light (not compatible with stoving & curing option)
- Air exhaust fan
- Moisture extraction option (comprising sealed seams and air exhaust fan)

Technical data

Model	Max. temp. [°C]	Temp. stability [°C]	Temp. uniformity [°C]	Heat-up time [mins]	Recovery time [mins]	Dimensions: Internal H x W x D [mm]	Dimensions: External H x W x D [mm]	Shelves fitted / accepted	Shelf loading each / total [kg]	Doors	Volume [litres]	Air changes / hr	Max. power [W]
GP 220A	300	±0.5	±5.0	75	24	610 x 610 x 610	1240 x 862 x 850 (Bench-top)	3 / 5	15 / 45	Single door	220	107*	3000
GP 330A	300	±0.5	±5.0	80	28	915 x 610 x 610	1545 x 862 x 850 (Floor-standing or optional stand)	4 / 8	15 / 60	Single door	330	76*	4500
GP 450A	300	±0.5	±5.0	75	30	1220 x 610 x 610	1850 x 862 x 850 (Floor-standing)	5 / 11	15 / 75	Single door	450	59*	6000
GP 220B	300	±0.5	±5.0	75	24	610 x 610 x 610	910 x 1190 x 850 (Bench-top)	3 / 5	15 / 45	Single door	220	107*	3000
GP 330B	300	±0.5	±5.0	80	30	610 x 915 x 610	910 x 1495 x 850 (Bench-top)	3 / 5	15 / 45	Double Door	330	76*	4500
GP 450B	300	±0.5	±5.0	75	35	610 x 1220 x 610	910 x 1800 x 850 (Bench-top)	3 / 5	20 / 60	Double Door	450	59*	6000

i Please note:

- Minimum operating temperature approximately ambient plus 30°C
- Uniformity is measured in an empty chamber with vents closed, after a stabilisation period
- Maximum power and heat up time based on a 240 V supply
- Stoving and curing option may require increased maximum power
- Shelf loadings are based on evenly distributed weight
- External dimensions with door closed
- The uniform volume is smaller than the total chamber volume
- * When equipped with optional exhaust fan



TLD – Rapid Cooling Ovens

These ovens are frequently used for annealing thermo-luminescent dosimeters (TLD) that have been used to measure exposure to ionising radiation.

The TLD ovens are designed to heat to 400 °C, cooling rapidly to ambient temperature using forced air cooling. This rapid cycling capability is also suitable for other small scale tempering and annealing applications.



TLD/3 with over-temperature option

Standard features

- 400 °C maximum operating temperature
- CC-T1 programmable controller providing automatic activation of the cooling blower
- Horizontal forced air circulation from rear mounted fan
- Excellent performance & reliability
- Stainless steel liner
- Stainless steel mesh shelves

Options (specify these at time of order)

- A range of sophisticated digital controllers, multi-segment programmers and data loggers is available. These can be fitted with RS232, RS485 or Ethernet communications (see pages 106 – 111)
- Independent over-temperature protection with digital setpoint & display

Technical data

CGH	Max. temp. [°C]	Temp. stability [°C]	Temperature uniformity [°C]	Heat-up time [mins]	Heating/cooling rate [°C/mins]	Dimensions: Internal H x W x D [mm]	Dimensions: External H x W x D [mm]	Shelves fitted / accepted	Shelf loading each / total [kg]	Volume [litres]	Max. power [W]	Weight [kg]
TLD/3	400	±1	±5.0	60	4*	150 x 150 x 100	530 x 370 x 500	2 / 2	1 / 2	3	1000	26
TLD/28	400	±1	±5.0	60	4*	305 x 305 x 305	880 x 675 x 865	2 / 2	10 / 20	28	2250	95

i Please note:

- Minimum operating temperature approximately ambient plus 50 °C
- Uniformity is measured in an empty chamber with vents closed, after a stabilisation period
- Maximum power and heat up time based on a 240 V supply

- External dimensions with door closed
- The uniform volume is smaller than the total chamber volume
- * Based upon cooling an empty chamber



HT – High Temperature Industrial Ovens

The HT high temperature ovens are manufactured in four standard chamber sizes with maximum operating temperatures of 400°C, 500°C and 600°C. Their robust construction incorporates heavy duty hinges, door catches and shelving systems.

This range also provides a foundation upon which a wide range of custom modifications can be added. Typical examples are the more sophisticated control systems and data recording that is required for applications such as AMS2750E heat treatment under Nadcap, or modifications to handle heavier loads or assist in loading and unloading the oven, or simply larger chamber sizes than are offered in the standard range.

Standard features

- 400°C, 500°C or 600°C operating temperatures
- Carbolite Gero 301 controller providing single ramp to set point
- 28, 95, 220 or 350 litre capacity
- Stainless steel liner and perforated shelves



HT 6/220 with 3216P1 programmer and over-temperature options

Options (specify these at time of order)

- A range of sophisticated digital controllers, multi-segment programmers and data loggers is available. These can be fitted with RS232, RS485 or Ethernet communications (see pages 106 – 111)
- Over-temperature protection (recommended to protect valuable contents & for unattended operation)
- Additional shelves
- Viewing window (not compatible with stoving and curing option)
- Stoving & curing options for extraction of small volumes of volatile solvents (not compatible with viewing window option or gas inlet option)
- Door interlock activated by temperature alarm relay (3216, CC-T1, 3508 or nanodac) or program segment output (CC-T1, 3508 or nanodac)

NEW Heavy duty options

Model	Reinforced base	Heavy duty shelves	
	Max. weight [kg]	Max. quantity	Max. weight / shelf [kg]
HT 28	40	2	20
HT 95	100	3	25
HT 220	150	4	50
HT 350	250	4	60

Please note: Reinforced base, shelf runners and shelves supplied as a package

Technical data

CGH Model	Max. temp. [°C]	Temp. stability [°C]	Temperature uniformity [°C]	Heat-up time [mins]	Recovery time [mins]	Dimensions: Internal H x W x D [mm]	Dimensions: External H x W x D [mm]	Shelves fitted / accepted	Shelf loading each / total [kg]	Volume [litres]	Max. power [W]
HT 4/28	400	±0.5	±5.0	60	10	305 x 305 x 305	880 x 685 x 885	2 / 2	10 / 20	28	1000
HT 4/95	400	±0.5	±5.0	60	10	455 x 455 x 455	1010 x 880 x 1120	3 / 4	15 / 30	94	3000
HT 4/220	400	±0.5	±5.0	60	10	610 x 610 x 610	1160 x 1030 x 1280	3 / 4	25 / 50	227	4000
HT 4/350	400	±0.5	±5.0	60	10	700 x 700 x 700	1775 x 1750 x 1200	3 / 3	25 / 50	343	6000
HT 5/28	500	±0.5	±5.0	60	16	305 x 305 x 305	880 x 685 x 885	2 / 2	10 / 20	28	2000
HT 5/95	500	±0.5	±5.0	60	16	455 x 455 x 455	1010 x 880 x 1120	3 / 4	15 / 30	94	4500
HT 5/220	500	±0.5	±5.0	60	16	610 x 610 x 610	1160 x 1030 x 1280	3 / 4	25 / 50	227	6000
HT 5/350	500	±0.5	±5.0	60	16	700 x 700 x 700	1775 x 1750 x 1200	3 / 3	25 / 50	343	7500
HT 6/28	600	±0.5	±5.0	75	20	305 x 305 x 305	880 x 685 x 885	2 / 2	10 / 20	28	2000
HT 6/95	600	±0.5	±5.0	70	20	455 x 455 x 455	1010 x 880 x 1120	3 / 4	15 / 30	94	4500
HT 6/220	600	±0.5	±5.0	90	20	610 x 610 x 610	1160 x 1030 x 1280	3 / 4	25 / 50	227	9000
HT 6/350	600	±0.5	±5.0	90	20	700 x 700 x 700	1775 x 1750 x 1200	3 / 3	25 / 50	343	12000
HT 7/28	700	±0.5	±5.0	90	24	305 x 305 x 305	905 x 735 x 885	2 / 2	8 / 16	28	3000
HT 7/95	700	±0.5	±5.0	95	24	455 x 455 x 455	1035 x 930 x 1120	3 / 4	10 / 30	94	6000
HT 7/220	700	±0.5	±5.0	120	24	610 x 610 x 610	1185 x 1080 x 1280	3 / 4	15 / 45	227	10000

- i** Please note:
- Minimum operating temperature approximately ambient plus 60°C
 - Uniformity is measured in an empty chamber with vents closed, after a stabilisation period
 - Maximum power and heat up time based on a 240 V supply

- Stoving and curing option increases the maximum power by 1500 W
- Shelf loadings are based on evenly distributed weight
- External dimensions with door closed
- The uniform volume is smaller than the total chamber volume



LGP – Large General Purpose Ovens

The LGP large general purpose ovens offer the greatest choice of options in size and maximum temperature. The range spans from 500 to more than 13000 litres, with a temperature span from 250°C to 700°C.

The LGP range is often customised in order to precisely meet the user's requirements.

Typical examples of which are the more sophisticated control systems and data recording that is required for applications such as AMS2750E heat treatment under Nadcap, or modifications to handle heavier loads or assist in loading and unloading the oven, or simply larger chamber sizes than are offered in the standard range.



LGP 2/3370 with exhaust fan option

Standard features

- 250°C, 425°C, 625°C or 700°C maximum operating temperatures
- PID digital set and display using the 3216CC controller
- 500 to 13820 litre chamber volumes
- Large capacity, rugged well proven designs
- Robust construction, for heavy duty cycles
- Efficient air circulation and excellent temperature uniformity from heavy duty impellers
- Corrosion resistant ferritic grade 430 stainless steel interior
- Steel section & zinc coated, painted mild steel exterior
- Single & double door models
- Shelf runners on models up to 1000 litres (optional on models up to 5830 litres)
- Low thermal mass insulation for fast response & energy efficiency
- Fully adjustable chamber ventilation
- Over-temperature protection (recommended to protect valuable contents & for unattended operation)
- **NEW** LGP 4/ and LGP 6/ models include independent element over-temperature protection



LGP 4/1000 with exhaust fan option

Options (specify these at time of order)

- A range of sophisticated digital controllers, multi-segment programmers and data loggers is available. These can be fitted with RS232, RS485 or Ethernet communications (see pages 106 – 111)
- Bespoke models are available for AMS2750E (Nadcap) compliant applications
- Access ports for cables & pipes
- Exhaust proving switch
- Manual or motorised vertically opening doors
- Vertical airflow impellers
- Explosion relief panels
- Interior light (subject to temperature limitations)
- Standard or heavy duty shelves
- A wide range of sample loading & handling accessories can also be supplied



Shelf runners and shelves information

Models 500, 730 and 1000 litres: supplied with 4 pairs of shelf runners as standard. Shelves are available at extra cost.

For the following models the shelf runners and shelves are available at additional cost:

Models 1500, 2160 and 3370 litres: available with 7 pairs of shelf runners.

Model 1750 litres: available with 5 pairs of shelf runners.

Model 5830 litres: available with 9 pairs of shelf runners.

Larger capacity models are not supplied with any shelf runners.

Technical data

CGH Model	Max. temp. [°C]	Temp. stability [°C]	Temperature uniformity [°C]	Heat-up time [mins]	Dimensions: Internal H x W x D [mm]	Dimensions: External H x W x D [mm]	Doors	Shelf loading each / total [kg]	Volume [litres]	Max. power [W]
LGP 2/500	250	±0.5	±5.0 @250°C	60	800 x 800 x 800	1300 x 1710 x 1350	Single door	50 / 200	500	9000
LGP 2/730	250	±0.5	±5.0 @250°C	60	900 x 900 x 900	1400 x 1810 x 1450	Single door	50 / 200	730	9000
LGP 2/1000	250	±0.5	±5.0 @250°C	60	1000 x 1000 x 1000	1500 x 1910 x 1550	Single door	50 / 200	1000	12000
LGP 2/1500	250	±0.5	±5.0 @250°C	60	1500 x 1000 x 1000	2000 x 1910 x 1550	Single door	50 / 350	1500	13500
LGP 2/1750	250	±0.5	±5.0 @250°C	60	1200 x 1200 x 1200	1700 x 2110 x 1750	Single door	50 / 250	1750	18000
LGP 2/2160	250	±0.5	±5.0 @250°C	60	1500 x 1200 x 1200	2000 x 2110 x 1750	Single door	50 / 350	2160	18000
LGP 2/3370	250	±0.5	±5.0 @250°C	60	1500 x 1500 x 1500	2000 x 3010 x 2050	Double door	50 / 350	3370	24000
LGP 2/5830	250	±0.5	±5.0 @250°C	60	1800 x 1800 x 1800	2300 x 3310 x 2350	Double door	50 / 450	5830	35000
LGP 2/8000	250	±0.5	±5.0 @250°C	60	2000 x 2000 x 2000	2500 x 3510 x 2550	Double door	-	8000	42000
LGP 2/13820	250	±0.5	±5.0 @250°C	60	2400 x 2400 x 2400	2900 x 3910 x 2950	Double door	-	13820	60000
LGP 4/500	425	±0.5	±5.0 @250°C	60	800 x 800 x 800	1450 x 1820 x 1520	Single door	50 / 200	500	9000
LGP 4/730	425	±0.5	±5.0 @250°C	60	900 x 900 x 900	1550 x 1920 x 1620	Single door	50 / 200	730	12000
LGP 4/1000	425	±0.5	±5.0 @250°C	60	1000 x 1000 x 1000	1650 x 2020 x 1720	Single door	50 / 200	1000	18000
LGP 4/1500	425	±0.5	±5.0 @250°C	60	1500 x 1000 x 1000	2150 x 2620 x 1720	Single door	50 / 350	1500	21000
LGP 4/1750	425	±0.5	±5.0 @250°C	60	1200 x 1200 x 1200	1850 x 2820 x 1920	Single door	50 / 250	1750	24000
LGP 4/2160	425	±0.5	±5.0 @250°C	60	1500 x 1200 x 1200	2150 x 2820 x 1920	Single door	50 / 350	2160	27000
LGP 4/3370	425	±0.5	±5.0 @250°C	60	1500 x 1500 x 1500	2150 x 3120 x 2220	Double door	50 / 350	3370	36000
LGP 4/5830	425	±0.5	±5.0 @250°C	60	1800 x 1800 x 1800	2450 x 3420 x 2520	Double door	50 / 350	5830	48000
LGP 4/8000	425	±0.5	±5.0 @250°C	60	2000 x 2000 x 2000	2650 x 3620 x 2720	Double door	50 / 450	8000	54000
LGP 6/500	625	±0.5	±5.0 @250°C	75	800 x 800 x 800	1450 x 1820 x 1520	Single door	50 / 200	500	13500
LGP 6/730	625	±0.5	±5.0 @250°C	75	900 x 900 x 900	1550 x 1920 x 1620	Single door	50 / 200	730	18000
LGP 6/1000	625	±0.5	±5.0 @250°C	75	1000 x 1000 x 1000	1650 x 2020 x 1720	Single door	50 / 200	1000	24000
LGP 6/1500	625	±0.5	±5.0 @250°C	75	1500 x 1000 x 1000	2150 x 2620 x 1720	Single door	50 / 350	1500	30000
LGP 6/1750	625	±0.5	±5.0 @250°C	75	1200 x 1200 x 1200	1850 x 2820 x 1920	Single door	50 / 250	1750	36000
LGP6/2160	625	±0.5	±5.0 @250°C	75	1500 x 1200 x 1200	2150 x 2820 x 1920	Single door	50 / 350	2160	40000
LGP 6/3370	625	±0.5	±5.0 @250°C	75	1500 x 1500 x 1500	2150 x 3120 x 2220	Double door	50 / 350	3370	48000
LGP 6/5830	625	±0.5	±5.0 @250°C	75	1800 x 1800 x 1800	2450 x 3420 x 2520	Double door	50 / 450	5830	72000
LGP 7/500	700	±0.5	±5.0 @250°C	-	800 x 800 x 800	1450 x 1820 x 1520	Single door	50 / 200	500	18000
LGP 7/730	700	±0.5	±5.0 @250°C	-	900 x 900 x 900	1550 x 1920 x 1620	Single door	50 / 200	730	21000
LGP 7/1000	700	±0.5	±5.0 @250°C	-	1000 x 1000 x 1000	1650 x 2020 x 1720	Single door	50 / 200	1000	27000
LGP 7/1500	700	±0.5	±5.0 @250°C	-	1500 x 1000 x 1000	2150 x 2620 x 1720	Single door	50 / 350	1500	33000

i Please note:

- Minimum operating temperature approximately ambient plus 35°C
- Uniformity is measured in an empty chamber with vents closed, after a stabilisation period
- Maximum power and heat up time based on a 240 V supply

- Shelf loadings are based on evenly distributed weight
- External dimensions with door closed
- The uniform volume is smaller than the total chamber volume



HTMA – High Temperature Modified Atmosphere Ovens

The HTMA range of modified atmosphere high temperature ovens is for use with inert atmospheres.

Separate flow controls for purge and process gases mean that once the chamber has been purged of atmospheric air process gas can be used with lower flow rates. Switching between purge and process gases can either be done manually or by adding the option of an automatic programmable control system. Oxygen levels down to 50 ppm are achievable.

Standard features

- 400 °C, 500 °C, 600 °C or 700 °C maximum operating temperatures
- Carbolite Gero 301 PID controller with single ramp to setpoint and including over-temperature protection
- 28, 95, 220, 500 & 1000 litre capacities
- Rear mounted fan & side air guides give horizontal 'airflow'
- Fully seam welded to contain modified atmosphere
- Manual gas control via needle valves & flowmeters (nickel brass)
- Corrosion resistant stainless steel interior with perforated shelves & runners
- Stainless steel pipe-work, nickel brass flow-meter & solenoid valves
- Single side hinged door, with metal heat seal & rubber gas tight seal, closed using non slam handle
- Gas inlet connection: bulkhead compression fitting to suit 10 mm outside diameter tube (maximum inlet pressure = 2 bar)



HTMA 6/28 with 3508P1 programmer and automatic gas control options

Options (specify these at time of order)

- A range of sophisticated digital controllers, multi-segment programmers and data loggers is available. These can be fitted with RS232, RS485 or Ethernet communications (see pages 106–111)
- Automatic gas control (requires a CC-T1, 3508 or Nanodac series programmable controller)
- Stainless steel flow-meter & solenoid valves, instead of nickel brass
- Fixed or castor mounted floor stands
- Oxygen sensor fitted to gas outlet to monitor oxygen level, displayed as percentage. Only available for use with nanodac™ instruments.
- **NEW** Door interlock activated by temperature alarm relay (3216, CC-T1, 3508 or nanodac) or program segment output (CC-T1, 3508 or nanodac)

Technical data

CGH	Max. temp. [°C]	Heat-up time [mins]	Recovery time [mins]	Dimensions: Internal H x W x D [mm]	Dimensions: External H x W x D [mm]	Shelves fitted / accepted	Shelf loading each / total [kg]	Volume [litres]	Max. power [W]	Weight [kg]
HTMA 4/28	400	60	10	305 x 305 x 305	990 x 810 x 885	2 / 2	10 / 20	28	1000	73
HTMA 4/95	400	75	16	455 x 455 x 455	1120 x 1015 x 1120	3 / 4	15 / 30	94	3000	99
HTMA 4/220	400	120	20	610 x 610 x 610	1270 x 1165 x 1280	3 / 4	25 / 50	227	4000	179
HTMA 4/500	400	-	-	800 x 800 x 800	1305 x 1115 x 1450	3 / 5	- / -	500	7500	-
HTMA 4/1000	400	-	-	1000 x 1000 x 1000	1310 x 1530 x 1635	3 / 5	- / -	1000	12000	-
HTMA 5/28	500	60	10	305 x 305 x 305	990 x 810 x 885	2 / 2	10 / 20	28	2000	73
HTMA 5/95	500	75	16	455 x 455 x 455	1120 x 1015 x 1120	3 / 4	15 / 30	94	4500	99
HTMA 5/220	500	120	20	610 x 610 x 610	1270 x 1165 x 1280	3 / 4	25 / 50	227	6000	179
HTMA 5/500	500	-	-	800 x 800 x 800	1305 x 1115 x 1450	3 / 5	- / -	500	9000	-
HTMA 5/1000	500	-	-	1000 x 1000 x 1000	1310 x 1530 x 1635	3 / 5	- / -	1000	15000	-
HTMA 6/28	600	60*	10*	305 x 305 x 305	990 x 810 x 885	2 / 2	10 / 20	28	2000	73
HTMA 6/95	600	75*	16*	455 x 455 x 455	1120 x 1015 x 1120	3 / 4	15 / 30	94	4500	99
HTMA 6/220	600	120*	20*	610 x 610 x 610	1270 x 1165 x 1280	3 / 4	25 / 50	227	9000	179
HTMA 6/500	600	-	-	800 x 800 x 800	1305 x 1115 x 1450	3 / 5	- / -	500	12000	-
HTMA 6/1000	600	-	-	1000 x 1000 x 1000	1310 x 1530 x 1635	3 / 5	- / -	1000	15000	-
NEW HTMA 7/28	700	90	24	305 x 305 x 305	1015 x 860 x 885	2 / 2	8 / 16	28	3000	85
NEW HTMA 7/95	700	95	24	455 x 455 x 455	1145 x 1065 x 1120	3 / 4	10 / 30	94	6000	115
NEW HTMA 7/220	700	120	24	610 x 610 x 610	1295 x 1215 x 1280	3 / 4	15 / 45	227	10000	195

i Please note:

- Minimum operating temperature approximately ambient plus 60°C
- Uniformity is measured in an empty chamber with vents closed, after a stabilisation period

- Maximum power and heat up time based on a 240 V supply
- External dimensions with door closed

* Nominal values based upon a representative sample of products



CR – Clean Room Ovens

The CR range of 250°C clean room ovens comprises nine standard models in sizes from the 30 litre model to the 1790 litre model which, once processed through a customer’s standard material entry regime, are suitable for operation within an **ISO 14644-1 Class 5** environment*. All sources of particulate contamination are fully sealed. Their easily cleaned stainless steel interiors and gloss white epoxy exteriors prevent the shedding of particulate contamination.

*Federal Standard 209E Class 100 was superseded in 2001 by ISO 14644-1 Class 5



CR 70 & CR 30

Standard features

- 250°C maximum operating temperature
- Carbolite Gero 301 controller with single ramp to setpoint
- 30 to 1790 litre chamber volumes
- Fully sealed low thermal mass insulation to avoid shedding fibres
- Fully enclosed brushless fan motor
- Perforated stainless steel shelves
- Particle free silicone rubber door seal
- Membrane control panel with clear bright LED display

Options (specify these at time of order)

- A range of sophisticated digital controllers, multi-segment programmers and data loggers is available. These can be fitted with RS232, RS485 or Ethernet communications (see pages 106 – 111)
- Over-temperature protection (recommended to protect valuable contents & for unattended operation)
- Access port for independent thermocouple
- Cable access port
- Viewing window
- Frame to enable units to be stacked one upon another
- Lockable door
- Door switch to isolate elements and fan
- Fully customised through wall (flange fitted) designs are available
- **NEW** Door interlock activated by temperature alarm relay (3216, CC-T1, 3508 or nanodac) or program segment output (CC-T1, 3508 or nanodac)

Technical data

CGH Model	Max. temp. [°C]	Temp. stability [°C]	Temperature uniformity [°C]	Heat-up time [mins]	Recovery time [mins]	Dimensions: Internal H x W x D [mm]	Dimensions: External H x W x D [mm]	Shelves fitted / accepted	Shelf loading each / total [kg]	Volume [litres]	Max. power [W]
CR/30	250	±0.2	±3.0 @ 250°C	35	4	310 x 310 x 310	685 x 460 x 670 (Bench-top or optional stand)	2 / 2	10 / 20	30	1000
CR/70	250	±0.2	±3.0 @ 250°C	35	4	310 x 470 x 470	685 x 620 x 820 (Bench-top or optional stand)	2 / 2	10 / 20	68	1500
CR/130	250	±0.2	±4.0 @ 250°C	35	4	550 x 470 x 470	925 x 620 x 820 (Bench-top or optional stand)	3 / 5	10 / 40	121	2000
CR/180	250	±0.2	±5.0 @ 250°C	58	5	770 x 470 x 470	1145 x 620 x 820 (Bench-top or optional stand)	3 / 7	10 / 50	170	2500
CR/220	250	±0.2	±5.0 @ 250°C	75	4	610 x 610 x 610	1360 x 940 x 970 (Bench-top or optional stand)	3 / 5	15 / 45	227	3000
CR/330	250	±0.2	±5.0 @ 250°C	80	6	915 x 610 x 610	1670 x 940 x 970 (Floor-standing or optional stand)	4 / 8	15 / 60	340	4500
CR/450	250	±0.3	±5.0 @ 250°C	75	9	1220 x 610 x 610	1930 x 940 x 970 (Floor-standing or optional stand)	5 / 11	15 / 75	450	6000
CR/840	250	±0.3	±5.0 @ 250°C	-	-	1525 x 915 x 610	2235 x 1395 x 970 (Floor-standing)	6	15 / -	850	12000
CR/1790	250	±0.3	±5.0 @ 250°C	-	-	1220 x 1220 x 1220	1930 x 1750 x 1580 (Floor-standing)	5	15 / -	1810	18000

i Please note:

- Minimum operating temperature approximately ambient plus 30°C
- Uniformity is measured in an empty chamber with vents closed, after a stabilisation period
- Maximum power and heat up time based on a 240 V supply

- Shelf loadings are based on evenly distributed weight
- External dimensions with door closed
- The uniform volume is smaller than the total chamber volume



HTCR – High Temperature Clean Room Ovens



HTCR 4/95

HTCR 6/28
with 3216P1 programmer option

The HTCR range of clean room ovens comprises **15 standard models with five sizes between 28 and 1000 litres available with maximum temperatures of 400 °C, 500 °C and 600 °C.**

Once processed through a customer's standard material entry regime HTCR Ovens are suitable for operation within an **ISO 14644-1 Class 6** environment. Federal Standard 209E Class 1000 was superseded in 2001 by ISO 14644-1 Class 6.

Optionally HTCR ovens can be supplied for operation within an **ISO 14644-1 Class 5** environment: Federal Standard 209E Class 100 was superseded in 2001 by ISO 14644-1 Class 5.

Airflow in HTCR

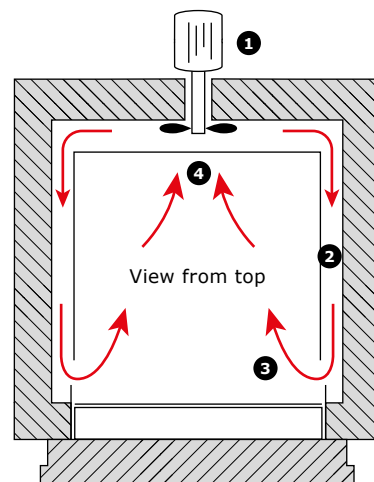

- 1) Air circulation fan
- 2) Heating elements heat the air
- 3) Heated air enters the chamber
- 4) Air from the chamber moves into the circulation fan

Airflow path as viewed from above

Standard features

- 400 °C, 500 °C or 600 °C maximum operating temperatures
- Carbolite Gero 301 PID controller with single ramp to setpoint and including over-temperature protection
- 28 to 1000 litre chamber volumes
- Fully sealed low thermal mass insulation avoids shedding fibres
- Fully enclosed brushless fan motor
- Smooth easily cleaned gloss epoxy exterior
- Polished stainless steel sealed interior
- Perforated stainless steel shelves
- Particle free silicone rubber door seal
- Membrane control panel with clear bright LED display
- Double skin construction for cool safe outer case temperature
- Door switch



HTCR – High Temperature Clean Room Ovens

Options (specify these at time of order)

- A range of sophisticated digital controllers, multi-segment programmers and data loggers is available. These can be fitted with RS232, RS485 or Ethernet communications (see pages 106 – 111)
- ISO-14644-1 Class 5 models are optionally available
- Access port for independent thermocouple
- Cable access port
- Lockable door
- Fixed or castor mounted floor stands
- Through wall (flange fitted) as well as fully bespoke designs are available
- **NEW** Door interlock activated by temperature alarm relay (3216, CC-T1, 3508 or nanodac) or program segment output (CC-T1, 3508 or nanodac)

Clean room classifications

Standard	Classification			
	5	6	7	8
ISO 14644-1	5	6	7	8
BS 5295	E/F	G/H	J	K
Federal standard 209E	100	1000	10000	100000

Technical data

CGH Model	Max. temp. [°C]	Temp. stability [°C]	Temp. uniformity [°C]	Heat-up time [mins]	Recovery time [mins]	Dimensions: Internal H x W x D [mm]	Dimensions: External H x W x D [mm]	Shelves fitted / accepted	Shelf loading each / total [kg]	Volume [litres]	Max. power [W]
HTCR 4/28	400	±0.5	±5.0 @ 250°C	60	10	305 x 305 x 305	880 x 675 x 885 (Bench-top or optional stand)	2 / 2	10 / 20	28	1000
HTCR 4/95	400	±0.5	±5.0 @ 250°C	90	10	455 x 455 x 455	1010 x 810 x 1120 (Bench-top or optional stand)	3 / 4	15 / 30	94	3000
HTCR 4/220	400	±0.5	±5.0 @ 250°C	75	16	610 x 610 x 610	1160 x 1030 x 1280 (Bench-top or optional stand)	3 / 4	10 / 50	227	4000
HTCR 4/500	400	±0.5	±5.0 @ 250°C	-	-	800 x 800 x 800	1305 x 1115 x 1450 (Floor-standing or optional stand)	3 / 5	-	510	7500
HTCR 4/1000	400	±0.5	±5.0 @ 250°C	-	-	1000 x 1000 x 1000	1310 x 1530 x 1635 (Floor-standing or optional stand)	3 / 5	-	1000	12000
HTCR 5/28	500	±0.5	±5.0 @ 250°C	75	16	305 x 305 x 305	880 x 675 x 885 (Bench-top or optional stand)	2 / 2	10 / 20	28	2000
HTCR 5/95	500	±0.5	±5.0 @ 250°C	110	16	455 x 455 x 455	1010 x 810 x 1120 (Bench-top or optional stand)	3 / 4	15 / 30	94	4500
HTCR 5/220	500	±0.5	±5.0 @ 250°C	105	16	610 x 610 x 610	1160 x 1030 x 1280 (Bench-top or optional stand)	3 / 4	10 / 50	227	6000
HTCR 5/500	500	±0.5	±5.0 @ 250°C	-	-	800 x 800 x 800	1305 x 1155 x 1450 (Floor-standing or optional stand)	3 / 5	10 / 20	510	9000
HTCR 5/1000	500	±0.5	±5.0 @ 250°C	-	-	1000 x 1000 x 1000	1310 x 1530 x 1635 (Floor-standing or optional stand)	3 / 5	15 / 30	1000	15000
HTCR 6/28	600	±0.5	±5.0 @ 250°C	110	20	305 x 305 x 305	880 x 675 x 885 (Bench-top or optional stand)	2 / 2	10 / 50	28	2000
HTCR 6/95	600	±0.5	±5.0 @ 250°C	110	20	455 x 455 x 455	1010 x 810 x 1120 (Bench-top or optional stand)	3 / 4	10 / 20	94	4500
HTCR 6/220	600	±0.5	±5.0 @ 250°C	120	20	610 x 610 x 610	1160 x 1030 x 1280 (Bench-top or optional stand)	3 / 4	15 / 30	227	9000
HTCR 6/500	600	±0.5	±5.0 @ 250°C	-	-	800 x 800 x 800	1305 x 1155 x 1450 (Floor-standing or optional stand)	3 / 5	-	510	12000
HTCR 6/1000	600	±0.5	±5.0 @ 250°C	-	-	1000 x 1000 x 1000	1310 x 1530 x 1635 (Floor-standing or optional stand)	3 / 5	-	1000	15000

i Please note:

- Minimum operating temperature approximately ambient plus 60°C
- Uniformity is measured in an empty chamber with vents closed, after a stabilisation period
- Maximum power and heat up time based on a 240 V supply

- External dimensions with door closed
- The uniform volume is smaller than the total chamber volume

Laboratory & Industrial Chamber Furnaces up to 1800 °C



Chamber Furnaces	Models	Page
Chamber Furnaces Selection Guide		28
Laboratory Chamber Furnaces	ELF, CWF, CWF-B, CWF-BAL, RWF, VCF, RHF, BLF, HTF	29
Industrial Chamber Furnaces	HTF, GPC, GPCMA, LCF, HB, SBCF	38
Annealing Furnaces	HRF, GLO	45
Ashing Furnaces Selection Guide		48
Ashing Furnaces	AAF, AAF-BAL, GSM, ABF	49

Carbolite Gero's extensive chamber furnace range has a maximum operating temperature of 1800 °C and chamber capacities up to 725 litres. They are suitable for a variety of laboratory, pilot scale and industrial applications. Although there is flexibility in size and temperature, if the application requires the use of modified atmosphere (above 1100 °C) or vacuum then a furnace from Carbolite Gero's tube furnace range should be selected.

Carbolite Gero's design features optimised uniform volume



The selection of a chamber furnace should take into account the following factors:

General considerations

- Chamber furnaces have the advantage of being able to heat larger items than tube furnaces
- The size of the chamber required and how it is loaded/unloaded will determine which style of furnace is best for the application
- For applications involving chemical vapours, gases or humidity please check with Carbolite Gero or your local dealer which furnace meets the requirements

What temperature?

- Carbolite Gero considers all products above 700 °C which are heated using radiant heat, (rather than convection), as furnaces
- The range of chamber furnaces is available up to a maximum operating temperature of 1800 °C
- Continuous operation of a furnace at its maximum temperature will reduce its life. Recommended maximum continuous operating temperature is 100 °C below the maximum operating temperature
- Furnaces are designed to operate at high temperatures. Operation below temperatures of approximately 600 °C will be less accurate and continuous use at low temperatures may reduce the element life of some furnaces, ie MoSi₂ heated furnaces
- Each furnace has a uniform working volume; this is a three-dimensional space which meets a specific tolerance and is smaller than the total chamber volume. Carbolite Gero's designs optimise this uniform volume for applications that require a specific temperature uniformity (the image top right shows a typical optimised uniform volume H x W x D)

Chamber design

- The simplest and least expensive furnaces have front opening side or bottom-hinged doors
- Higher specification front opening 'up and away' vertically lifting doors keep the hot face insulation away from the operator, increasing safety and comfort
- Where tall objects and crucibles need lifting in and out of the chamber, vertically loading furnaces with heating elements in the chamber sides are available
- Bottom loading furnaces allow the load to be lifted into the heated chamber, or lowered to cool them

Modified atmosphere

To work with inert gases or modified atmosphere, one of the following options must be selected at order placement:

- A gasket, elastomer seal or sand sealed retort in a front opening chamber furnace
- An inverted crucible on a modified hearth in a bottom loading furnace (BLF 1600°C, 1700°C and 1800°C models)

Temperature control

- All furnaces are supplied with accurate PID (proportional, integral and derivative) single ramp to setpoint controllers providing accurate control and minimal temperature overshoot. Higher temperature furnaces feature an 8-segment programmer as standard
- Multi-segment and/or multi-program controllers are available as an option on most models, please see pages 106 – 111
- Over-temperature protection is strongly recommended when a furnace is operating whilst unattended, or where the sample is valuable

Application specific and custom built furnaces

Carbolite Gero designs and manufactures all the furnaces within its range. Many options are available, as well as fully customised furnaces for specific applications. For examples of custom built furnaces and ovens please see page 97 or separate catalogue 'Custom Designed Ovens & Furnaces up to 1800°C'

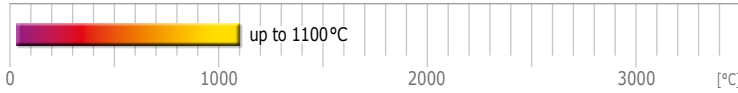

ELF – Economy Chamber Furnaces

The ELF laboratory furnaces comprise three bench mounted models designed for light duty and general use up to 1100 °C.

They have a simple drop down door and a top mounted ceramic chimney. The combination of low thermal mass insulation and free radiating wire elements embedded in the chamber sides provide efficient heating.

Standard features

- 1100 °C maximum operating temperature
- Carbolite Gero 301 controller with single ramp to setpoint and process timer
- 6, 14 or 23 litre chamber volumes
- Drop down door with air gap to minimise external temperature
- Delayed start / process timer function as standard
- Vacuum formed, low thermal mass insulation
- Hard ceramic hearth fitted as standard
- Ventilated via top mounted ceramic chimney



ELF 11/6

Options (specify these at time of order)

- Over-temperature protection (recommended to protect valuable contents & for unattended operation)

Heat-up and cool down rates for ELF 11/6

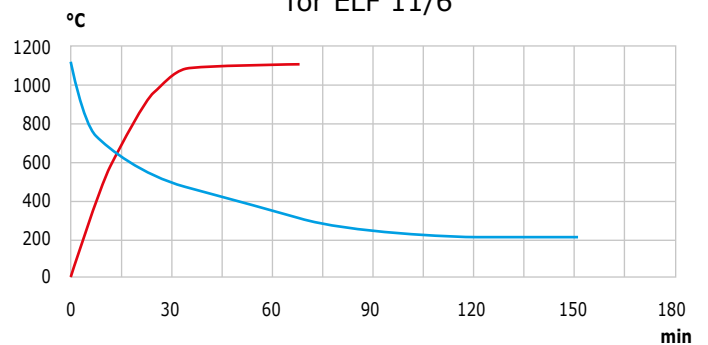

Technical data

Model	Max. temp. [°C]	Heat-up time [mins]	Max. continuous operating temp. [°C]	Dimensions: Usable chamber H x W x D [mm]	Dimensions: External H x W x D [mm]	Temperature uniformity of ±5 °C within H x W x D [mm]	Volume [litres]	Max. power [W]	Holding power [W]	Thermocouple type	Weight [kg]
ELF 11/6	1100	28	1000	165 x 180 x 210	580 x 410 x 420	125 x 140 x 140	6	2000	900	K	24
ELF 11/14	1100	43	1000	210 x 220 x 310	630 x 450 x 520	170 x 180 x 205	14	2600	1300	K	31
ELF 11/23	1100	26	1000	235 x 255 x 400	715 x 505 x 690	195 x 215 x 305	23	5000	1550	K	52

i Please note:
 - Heat up time is measured to 100°C below max, using an empty chamber
 - Holding power is measured at continuous operating temperature

- External dimensions with door closed and including chimney
 - The uniform volume is smaller than the total chamber volume

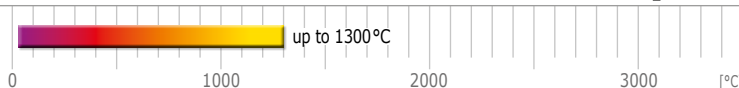

CFW, CWF-B and CWF-BAL Standard Chamber Furnaces

The CWF range of general purpose laboratory chamber furnaces is bench mounted. Models are available in five sizes with a maximum operating temperature up to 1300°C.

The airflow in the CWF-B furnaces is enhanced by the addition of air inlet holes in the door and a tall chimney which rapidly removes the fumes from the furnace.

Standard features

- Carbolite Gero 301 controller with single ramp to setpoint and process timer
- Soft closing door on 5, 13, 21 & 23 litre models
- Vertical lift door keeps heated surface away from the user
- Delayed start / process timer function as standard
- Hard wearing alumina element carriers, furnace entrance & hearth
- Energy efficient low thermal mass insulation
- Free radiating wire wound elements for optimum uniformity
- Easy access to elements & controls simplifies maintenance & servicing

CFW:

- 1100°C, 1200°C or 1300°C maximum operating temperature
- 5, 13, 23, 36 or 65 litre chamber volumes

CFW-B:

- Enhanced airflow from tall chimney & door vents for full combustion

CFW-BAL:

- With integrated balance that runs independently of the furnace control system
- Software supplied with the balance may be used to monitor the balance reading via a computer
- Maximum capacity of balance is 3 kg with a resolution of 0.01 g (other capacities available)

Options (specify these at time of order)

- A range of sophisticated digital controllers, multi-segment programmers and data loggers is available. These can be fitted with RS232, RS485 or Ethernet communications (see pages 106 – 111)
- Over-temperature protection (recommended to protect valuable contents & for unattended operation)
- A range of Inconel retorts to work with modified atmospheres up to 1100°C, please see page 119 for additional information
- AMS2750E Nadcap compatible models are available for aerospace applications
- CWF-BAL: 8 kg balance with a resolution of 0.1 g



CFW 11/13 with CC-T1 temperature programmer

The CWF-BAL furnace with integral balance can be used for thermogravimetric analysis (TGA) and loss on ignition (LOI) applications, where weight change of the sample must be monitored during the heating process. This is required, for example, in the determination of inorganic matter content in materials such as cement, lime, calcinated bauxite and refractories. For applications involving organic matter content, please refer to page 51 for the AAF-BAL.

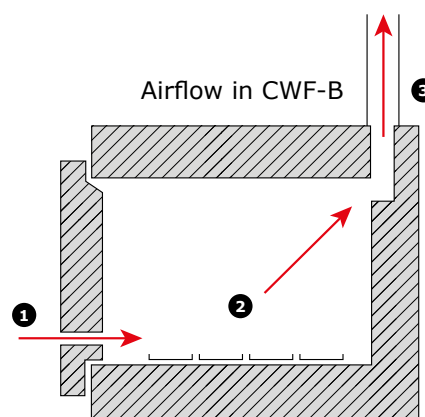

- 1) Air inlets through the door plug
- 2) Airflow through the chamber promotes burning of the samples

- 3) Chimney pulls air through the chamber

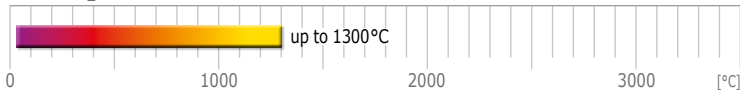

CFW, CWF-B and CWF-BAL Standard Chamber Furnaces



CWF 12/36 with 3216P1 programmer option



CWF-BAL 11/21 with optional Nanodac data logger

Technical data

CGH Model	Max. temp. [°C]	Heat-up time [mins]	Max. continuous operating temperature [°C]	Dimensions: Usable chamber H x W x D [mm]	Dimensions: External H x W x D [mm]	Dimensions: External with door open H x W x D [mm]	Temperature uniformity of $\pm 5^\circ\text{C}$ within H x W x D [mm]	Volume [litres]	Max. power [W]	Weight [kg]
Standard Chamber Furnaces										
CWF 11/5	1100	47	1000	135 x 140 x 250	585 x 375 x 485	800 x 375 x 485	85 x 90 x 110	5	2400	30
CWF 11/13	1100	90	1000	200 x 200 x 325	655 x 435 x 610	905 x 435 x 610	120 x 120 x 185	13	3100	47
CWF 11/23	1100	36	1000	235 x 245 x 400	705 x 505 x 675	990 x 505 x 675	155 x 165 x 285	23	7000	68
CWF 12/5	1200	51	1100	135 x 140 x 250	585 x 375 x 485	800 x 375 x 485	85 x 90 x 125	5	2400	30
CWF 12/13	1200	80	1100	200 x 200 x 325	655 x 435 x 610	905 x 435 x 610	120 x 120 x 200	13	3100	47
CWF 12/23	1200	45	1100	235 x 245 x 400	705 x 505 x 675	990 x 505 x 675	155 x 165 x 325	23	7000	68
CWF 12/36	1200	37	1100	250 x 320 x 450	810 x 690 x 780	1105 x 690 x 780	170 x 240 x 357	36	9000	100
CWF 12/65	1200	40	1100	278 x 388 x 595	885 x 780 x 945	1245 x 780 x 945	178 x 288 x 455	65	14000	165
CWF 13/5	1300	75	1200	135 x 140 x 250	585 x 375 x 485	800 x 375 x 485	85 x 90 x 150	5	2400	30
CWF 13/13	1300	115	1200	200 x 200 x 325	655 x 435 x 610	905 x 435 x 610	120 x 120 x 225	13	3100	47
CWF 13/23	1300	55	1200	235 x 245 x 400	705 x 505 x 675	990 x 505 x 675	155 x 165 x 340	23	7000	68
CWF 13/36	1300	47	1200	250 x 320 x 450	810 x 690 x 780	1105 x 690 x 780	170 x 240 x 400	36	9000	100
CWF 13/65	1300	45	1200	278 x 388 x 595	885 x 780 x 945	1245 x 780 x 945	178 x 288 x 520	65	14000	165
Burn-off Chamber Furnaces										
CWF-B 11/13	1100	103	1000	200 x 200 x 325	655 x 435 x 610	905 x 435 x 610	n/a	13	3100	47
CWF-B 12/13	1200	130	1100	200 x 200 x 325	655 x 435 x 610	905 x 435 x 610	n/a	13	3100	47
Chamber Furnace with Integral Balance										
CWF-BAL 11/21	1100	60	1000	215 x 245 x 400	705 x 505 x 675 (400 x 170 x 500)*	990 x 505 x 675	n/a	21	7000	80

i Please note:
 - Heat up time is measured to 100°C below max, using an empty chamber
 - Holding power is measured at continuous operating temperature
 - Maximum power and heat up time based on a 240 V supply

- The uniform volume is smaller than the total chamber volume
 * Dimensions of control box

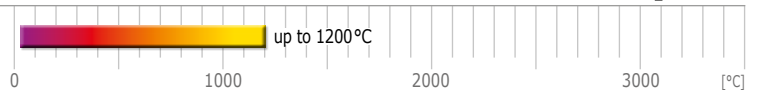

RWF – Rapid Heating Chamber Furnaces

The RWF rapid wire chamber furnaces are available in three chamber sizes with maximum operating temperatures of 1100 °C or 1200 °C.

The free radiating wire elements in combination with low thermal mass insulation are designed to provide rapid thermal response within the chamber.

Standard features

- 1100 °C or 1200 °C maximum operating temperature
- Carbolite Gero 301 controller, with single ramp to setpoint & process timer
- 5, 13 or 23 litre chamber volumes
- Ambient to 1000 °C in as little as 10 minutes
- Rapid thermal response from free radiating coiled wire elements
- Low thermal mass insulation for fast response & energy efficiency
- Soft closing vertical lift door keeps heated surface away from the user
- Hard wearing hearth



RWF 12/5

Options (specify these at time of order)

- A range of sophisticated digital controllers, multi-segment programmers and data loggers is available. These can be fitted with RS232, RS485 or Ethernet communications (see pages 106 – 111)
- Over-temperature protection (recommended to protect valuable contents & for unattended operation)

Heat-up and cool down rates for RWF 12/13

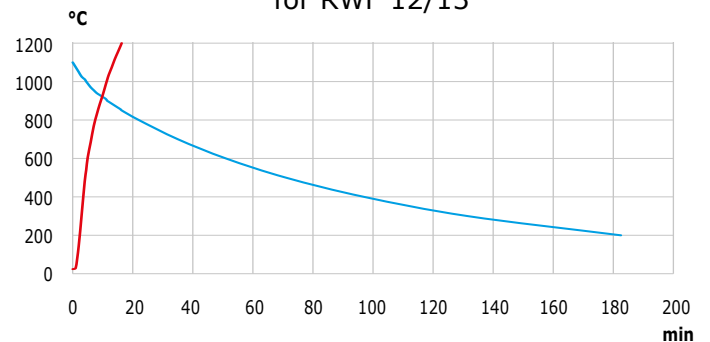

Technical data

CGH	Max. temp. [°C]	Heat-up time [mins]	Max. continuous operating temperature [°C]	Dimensions: Usable chamber H x W x D [mm]	Dimensions: External H x W x D [mm]	Dimensions: External with door open H x W x D [mm]	Volume [litres]	Max. power [W]	Holding power [W]	Thermocouple type	Weight [kg]
RWF 11/5	1100	10	1000	130 x 160 x 250	585 x 375 x 325	800 x 375 x 325	5	2750	680	K	28
RWF 11/13	1100	11	1000	195 x 210 x 325	655 x 435 x 610	905 x 435 x 610	13	5000	1200	K	45
RWF 11/23	1100	13	1000	220 x 260 x 400	705 x 505 x 675	990 x 505 x 675	23	9100	1800	K	65
RWF 12/5	1200	12	1100	130 x 160 x 250	585 x 375 x 485	800 x 375 x 485	5	2750	820	R	28
RWF 12/13	1200	13	1100	195 x 210 x 325	655 x 435 x 610	905 x 435 x 610	13	5000	1450	R	45
RWF 12/23	1200	15	1100	220 x 260 x 400	705 x 505 x 675	990 x 505 x 675	23	9100	2100	R	65

i Please note:

- Heat up time is measured to 100 °C below max, using an empty chamber
- Holding power is measured at continuous operating temperature

- Maximum power and heat up time based on a 240 V supply
- The uniform volume is smaller than the total chamber volume

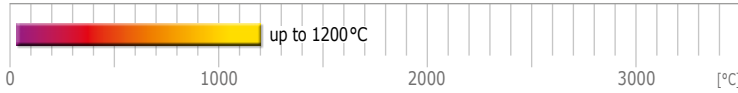

VCF – Top Loading Chamber Furnaces

These top loading chamber furnaces are particularly suited for applications involving tall crucibles and heavy components.

Heating elements in all four walls minimise the risk of damage from spills and ensures good temperature uniformity. The smaller two furnaces may be bench-mounted, but best access is provided when these furnaces are located on the floor.

Standard features

- 1200 °C maximum operating temperature
- Carbolite Gero 301 controller with single ramp to setpoint & process timer
- 5, 10, 23 or 100 litre chamber volume
- Free radiating wire elements in all 4 sides of chamber
- Vented top opening door
- Angled control panel, protected but clearly visible
- Thermocouple protected by ceramic sheath



VCF 12/5 with 3508P1 programmer option

Options (specify these at time of order)

- A range of sophisticated digital controllers, multi-segment programmers and data loggers is available. These can be fitted with RS232, RS485 or Ethernet communications (see pages 106 – 111)
- Over-temperature protection (recommended to protect valuable contents & for unattended operation)

Technical data

CGH Model	Max. temp. [°C]	Heat-up time [mins]	Dimensions: Usable chamber H x W x D [mm]	Dimensions: External H x W x D [mm]	Volume [litres]	Max. power [W]	Holding power [W]	Thermocouple type	Weight [kg]
VCF 12/5	1200	102	260 x 155 x 130	660 x 530 x 405 (Floor-standing)	5	2500	900	R	50
VCF 12/10	1200	138	365 x 180 x 155	765 x 555 x 430 (Floor-standing)	10	3000	1200	R	60
VCF 12/23	1200	125	450 x 250 x 200	850 x 600 x 500 (Floor-standing)	23	6000	2500	R	130
VCF 12/100	1200	150	600 x 410 x 410	1100 x 930 x 950 (Floor-standing)	100	15000	6000	R	200

i Please note:
 - Maximum continuous operating temperature is 100°C below maximum temperature
 - Heat up time is measured to 100°C below max, using an empty chamber

- Holding power is measured at continuous operating temperature
 - The uniform volume is smaller than the total chamber volume

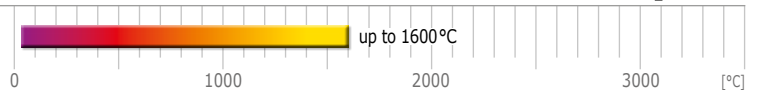

RHF – High Temperature Chamber Furnaces

The RHF range of silicon carbide heated high temperature chamber furnaces comprises four chamber sizes, each available with three maximum operating temperatures of 1400 °C, 1500 °C and 1600 °C.

Robust construction and high quality elements provide rapid heating rates (typically reaching 1400 °C in under 40 minutes) and a long reliable working life.

Standard features

- 1400 °C, 1500 °C or 1600 °C maximum operating temperature
- Carbolite Gero 301 PID controller with single ramp to setpoint & process timer
- 3, 8, 15 or 35 litre chamber volumes
- Soft closing vertical lift door (3 & 8 litre models only)
- Silicon carbide heating elements provide long life and are able to withstand the stresses of intermittent operation
- RHF 3 & 8 litre have a cast alumina hearth
RHF 15 & 35 have silicon carbide hearth
- Low thermal mass insulation for energy efficiency & rapid heating & cooling



RHF 15/3 with 3508P1 programmer option

Options (specify these at time of order)

- A range of sophisticated digital controllers, multi-segment programmers and data loggers is available. These can be fitted with RS232, RS485 or Ethernet communications (see pages 106 – 111)
- Over-temperature protection (recommended to protect valuable contents & for unattended operation)
- Silicon carbide protection tiles (see details on the opposite page)

Power supplies for RHF furnaces

A characteristic of the control systems used with silicon carbide elements results in a power supply which will be larger than expected e.g. RHF 14/3 at 4500 W =

- Single phase / 200 – 240 V / 30 A or
- 2 phase / 380 – 415 V / 15 A per phase.

See pages 122 – 125 for power supply information.



RHF 16/35 with 3216P1 programmer and over-temperature options

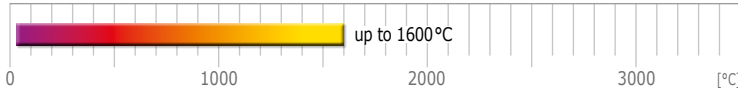

NEW SiC protection tile option

The RHF chamber furnace range is available with optional heating element protection tiles. When this option is specified, silicon carbide (SiC) tiles are added to the insulation assembly, positioned on both sides of the chamber to create a barrier between the working chamber and the heating elements. This will protect the heating elements from potentially harmful contaminants that might be placed in the chamber.

The addition of the heating element protection tiles option reduces the width of the internal chamber and the maximum operating temperature. The table below shows the amended technical data.

Technical data (SiC option)

Model	Max. temp. [°C]	Dimensions: Usable chamber H x W x D [mm]	Volume [litres]
RHF 14/3	1300	120 x 80 x 205	2
RHF 14/8	1300	170 x 130 x 270	6
RHF 14/15	1300	220 x 180 x 310	12
RHF 14/35	1300	250 x 260 x 465	30
RHF 15/3	1400	120 x 80 x 205	2
RHF 15/8	1400	170 x 130 x 270	6
RHF 15/15	1400	220 x 180 x 310	12
RHF 15/35	1400	250 x 260 x 465	30
RHF 16/3	1500	120 x 80 x 205	2
RHF 16/8	1500	170 x 130 x 270	6
RHF 16/15	1500	220 x 180 x 310	12

Application examples

- If the process creates small amounts of acid, NOx or water.
- Burn-off processes which create a lot of fumes.
- Melting different kinds of glass which emit aggressive gases.
- This option can also be specified in combination with a gas inlet where the user requires reduced oxygen content in the chamber. The protection tiles prevent gases leaking out of the chamber through the double spiral heating elements.

Note: The additional protection tiles reduce the width of the standard chamber, and reduce the maximum temperature achievable in the chamber.

RHF chamber with SiC protection tiles

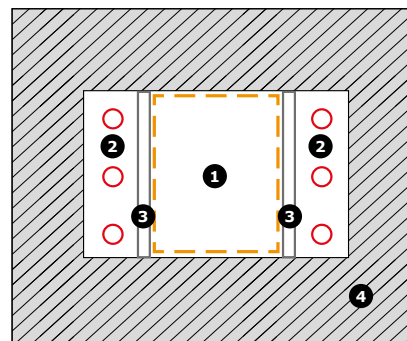

- 1) Working chamber
- 2) Heating elements
- 3) SiC protection tiles
- 4) Thermal insulation

Technical data

CGH Model	Max. temp. [°C]	Heat-up time [mins]	Dimensions: Usable chamber H x W x D [mm]	Dimensions: External with door open H x W x D [mm]	Volume [litres]	Holding power [W]	Max. power [W]	Thermo-couple type	Weight [kg]
RHF 14/3	1400	33	120 x 120 x 205	655 x 435 x 610 (905) (Bench-top)	3	1900	4500	R	42
RHF 14/8	1400	22	170 x 170 x 270	705 x 505 x 675 (990) (Bench-top)	8	3200	8000	R	64
RHF 14/15	1400	35	220 x 220 x 310	810 x 690 x 780 (1105) (Bench-top)	15	2900	10000	R	125
RHF 14/35	1400	38	250 x 300 x 465	885 x 780 x 945 (1245) (Bench-top)	35	6000	16000	R	179
RHF 15/3	1500	45	120 x 120 x 205	655 x 435 x 610 (905) (Bench-top)	3	2000	4500	R	46
RHF 15/8	1500	40	170 x 170 x 270	705 x 505 x 675 (990) (Bench-top)	8	3500	8000	R	61
RHF 15/15	1500	46	220 x 220 x 310	810 x 690 x 780 (1105) (Bench-top)	15	3000	10000	R	125
RHF 15/35	1500	46	250 x 300 x 465	885 x 780 x 945 (1245) (Bench-top)	35	6200	16000	R	178
RHF 16/3	1600	42	120 x 120 x 205	655 x 435 x 610 (905) (Bench-top)	3	2300	4500	R	42
RHF 16/8	1600	35	170 x 170 x 270	705 x 505 x 675 (990) (Bench-top)	8	4000	8000	R	61
RHF 16/15	1600	58	220 x 220 x 310	810 x 690 x 780 (1105) (Bench-top)	15	3500	10000	R	140
RHF 16/35	1600	113	250 x 300 x 465	1530 x 900 x 1020 (1885) (Floor-standing)	35	7000	16000	R	270

i Please note:
 - Maximum continuous operating temperature is 100°C below maximum temperature
 - Heat up time is measured to 100°C below max, using an empty chamber

- Holding power is measured at continuous operating temperature
 * when the SiC protection tile option is applied

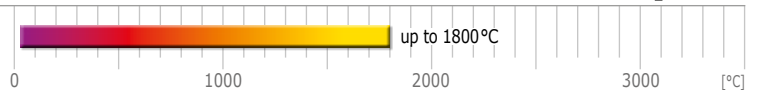

BLF – High Temperature Bottom Loading Furnaces

BLF bottom loading furnaces use an electrically operated elevator hearth, which as it rises into the furnace chamber, lifts the load into the heated zone.

This furnace provides the following advantages: easy loading of samples and uniform heating achieved by locating elements in all six side walls of the chamber.

Standard features

- 1600 °C, 1700 °C & 1800 °C maximum operating temperature
- Programmable 3216P1 controller
- 3 to 21 litre capacities
- Ideal for: sintering high performance ceramics, melting glass under high temperature or working with modified atmospheres
- Rapid heating & cooling cycles can be achieved through raising & lowering the hearth
- Electrically operated elevator hearth protects operator from the chamber's radiant heat
- Hearth cage with safety interlock
- Excellent temperature uniformity as a result of the hexagonal chamber
- Over-temperature protection to protect load or furnace during unattended operation
- 1600 °C model heated by silicon carbide elements
- 1700 °C & 1800 °C models heated by molybdenum disilicide elements



BLF 17/3 with optional CC-T1 touchscreen programmer

The 1600 °C is ideal for sintering of zirconia dental crowns and frameworks. The silicon carbide heating elements will not cause discolouration of the zirconia.

Options (specify these at time of order)

- A range of sophisticated digital controllers, multi-segment programmers and data loggers is available. These can be fitted with RS232, RS485 or Ethernet communications (see pages 106 – 111)
- Compatible crucibles
- Modified hearth for the introduction of gases into an inverted crucible (not gas tight)
- Radiation shutter
- Customised options including: adaptation to introduce thermocouple or stirrer through the chamber roof and rotating hearth
- Plasma sprayed alumina protection tube to protect heating elements from sample contamination

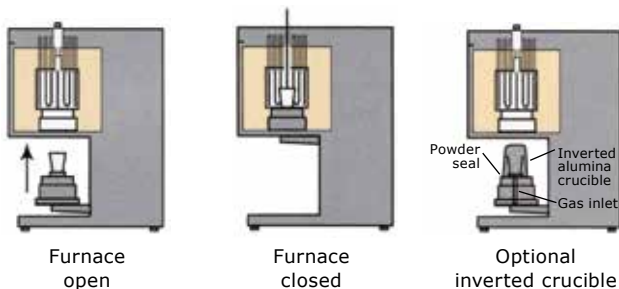

Technical data

CGH Model	Max. temp. [°C]	Heat-up time [mins]	Dimensions: Usable chamber H x Diameter [mm]	Dimensions: External H x W x D [mm]	Volume [litres]	Max. power [W]	Thermocouple type	Weight [kg]
BLF 16/3	1600	80	190 x 150	1025 x 750 x 530 (Bench-top)	3	6000	R	155
BLF 17/3	1700	80	190 x 150	975 x 750 x 530 (Bench-top)	3	4125	B	155
BLF 17/8	1700	80	250 x 200	1950 x 1360 x 880 (Floor-standing)	8	8130	B	424
BLF 17/21	1700	180	300 x 300	1850 x 1250 x 900 (Floor-standing)	21	12000	B	600
BLF 18/3	1800	112	190 x 150	975 x 750 x 530 (Bench-top)	3	4775	Pt20 %Rh/Pt40 %Rh	155
BLF 18/8	1800	110	250 x 200	1950 x 1360 x 880 (Floor-standing)	8	7010	Pt20 %Rh/Pt40 %Rh	424
BLF 18/21	1800	220	300 x 300	1850 x 1250 x 900 (Floor-standing)	21	12000	Pt20 %Rh/Pt40 %Rh	600

i Please note:

- Maximum continuous operating temperature is 100°C below maximum temperature
- Heat up time is measured to 100°C below max, using an empty hearth

- For 1700°C and 1800°C models, a chemical reaction between the heating elements and zirconia may discolour the zirconia. Processing advice or alternative elements are available; please enquire.

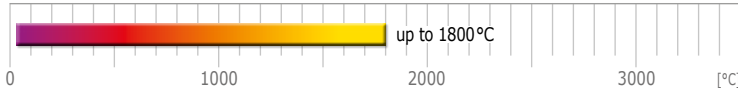

HTF – High Temperature Laboratory Chamber Furnaces

The laboratory HTF high temperature chamber furnace range comprises 1700 °C and 1800 °C models.

These furnaces may be customised in order to satisfy specific customer requirements, e.g. the addition of catalytic afterburners for ceramic binder burn-off applications.

Standard features

- 1700 °C & 1800 °C maximum operating temperatures
- Programmable 3216P1 controller
- From 4 to 10 litre capacities
- High quality molybdenum disilicide heating elements
- Vertical lift door keeps hot face away from user
- Advanced refractory interior, used in combination with energy efficient low thermal mass insulation
- Over-temperature protection
- Fan cooling for low external case temperature



HTF 17/5 with optional touchscreen programmer

Cool down rates for HTF 17/10

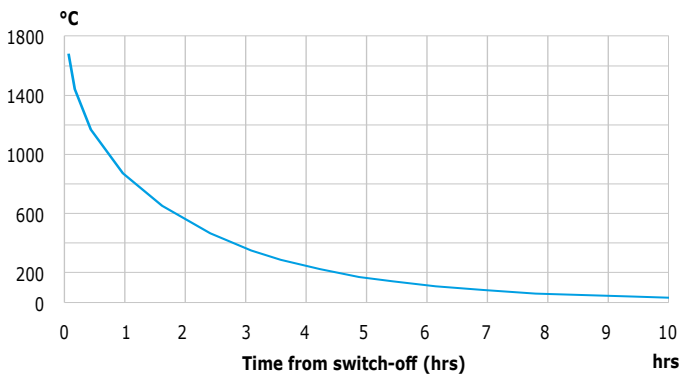

Options (specify these at time of order)

- A range of sophisticated digital controllers, multi-segment programmers and data loggers is available. These can be fitted with RS232, RS485 or Ethernet communications (see pages 106 – 111)

Technical data

CGH Model	Max. temp. [°C]	Heat-up time [mins]	Dimensions: Usable chamber H x W x D [mm]	Dimensions: External with door open H x W x D [mm]	Volume [litres]	Max. power [W]	Thermocouple type	Weight [kg]
HTF 17/5	1700	50	158 x 150 x 225	565 x 830 x 650 (850) (Bench-top)	5	4050	B	109
HTF 17/10	1700	44	232 x 200 x 225	565 x 830 x 650 (850) (Bench-top)	10	5920	B	133
HTF 18/4	1800	65	140 x 140 x 190	565 x 830 x 650 (850) (Bench-top)	4	4650	Pt20%Rh/Pt40%Rh	115
HTF 18/8	1800	56	210 x 190 x 190	565 x 830 x 650 (850) (Bench-top)	8	6200	Pt20%Rh/Pt40%Rh	128

i Please note:
 - Maximum continuous operating temperature is 100°C below maximum temperature
 - Heat up time is measured to 100°C below max, using an empty chamber

- Chemical reaction between the heating elements and zirconia may discolour the zirconia. Processing advice or alternative elements are available; please enquire.

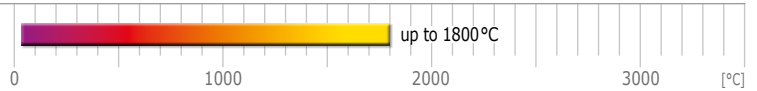

HTF – High Temperature Industrial Chamber Furnaces

The industrial HTF chamber furnace is available in usable volumes of 27 to 514 litres.

Independent over-temperature protection is fitted as standard for unattended operation.

If debinding is required before sintering, Carbolite Gero offers a debinding package for the HTF. The debinding package consists of an inlet for preheated air, several gas inlets, and an afterburner. The preheated air is simultaneously purged through several gas inlets which improves temperature uniformity at low temperatures and envelops the sample in the incoming air. All gaseous by-products generated during the debinding process are burnt in an afterburner that is driven by propane gas and compressed air. On completion of debinding, the furnace temperature will increase to begin the sintering process.



HTF 18/165 with optional Nadcap compliance



HTF 17/27

Standard features

- 1600 °C, 1700 °C & 1800 °C maximum operating temperatures
- Programmable 3216P1 controller
- From 27 to 514 litre capacities
- High quality molybdenum disilicide heating elements
- Advanced refractory interior, used in combination with energy efficient low thermal mass insulation
- Over-temperature protection

Options (specify these at time of order)

- A range of sophisticated digital controllers, multi-segment programmers and data loggers is available. These can be fitted with RS232, RS485 or Ethernet communications (see pages 106 – 111). Please note that special controllers may be needed for this model
- Debinding in air with the debinding package
- Gas supply with manually adjustable flow meter is available
- Modification of the atmosphere in the furnace chamber can be achieved but oxygen cannot be removed completely because it is not gas tight

Technical data

CGN Model	Max. temp. [°C]	Max. heat-up rate [°C/min]	Cooling time [h]	Dimensions: Usable chamber H x W x D [mm]	Dimensions: External H x W x D [mm]	Volume [litres]	Max. power [W]
HTF __/27	1700, 1800	10	10	300 x 300 x 300	1610 x 780 x 945 (door open H 1935)	27	10000
HTF __/64	1600, 1700, 1800	10	12	400 x 400 x 400	2000 x 1000 x 1200	64	16000
HTF __/128	1600, 1700, 1800	10	12	400 x 400 x 800	2000 x 1000 x 1500	128	40000
HTF __/165	1600, 1700, 1800	10	13	550 x 550 x 550	2450 x 1400 x 1400 (door open)	165	40000
HTF __/250	1600, 1700, 1800	10	14	500 x 500 x 1000	2000 x 1000 x 1500	250	-
HTF __/430	1600, 1700, 1800	-	-	600 x 600 x 1200	2400 x 1500 x 2000	430	-
HTF __/514	1600, 1700, 1800	-	-	780 x 550 x 1200	2400 x 1500 x 2000	514	-

i Please note:
 - Maximum continuous operating temperature is 100°C below maximum temperature

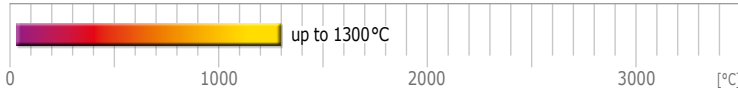

GPC – General Purpose Chamber Furnaces

The GPC general purpose chamber furnaces are larger floor-standing models. Available at 1200°C and 1300°C with capacities ranging from 131 to 350 litres.

Standard features

- 1200°C or 1300°C maximum operating temperature
- Programmable 3216P1 controller
- Over-temperature protection
- 131, 200, 300 or 350 litre chamber volumes
- Free radiating coiled wire elements on two sides and roof
- All models have under hearth heating
- Low thermal mass insulation for fast response & energy efficiency
- Up & away door keeps heated surface away from the user
- Hard wearing refractory hearth plate resists damage & supports heavier loads
- Heating elements are easily serviced



GPC 12/131 with optional custom built sample support rack

Options (specify these at time of order)

- A range of sophisticated digital controllers, multi-segment programmers and data loggers is available. These can be fitted with RS232, RS485 or Ethernet communications (see pages 106 – 111)
- AMS2750E Nadcap compatible models are available for aerospace applications
- Various loading and unloading management options can be supplied

Technical data

CGH Model	Max. temp. [°C]	Heat-up time [mins]	Max. continuous operating temperature [°C]	Dimensions: Usable chamber H x W x D [mm]	Dimensions: External with door open H x W x D [mm]	Volume [litres]	Max. power [W]	Thermocouple type	Weight [kg]
GPC 12/131B	1200	150	1100	350 x 500 x 750	1860 x 1260 x 1230 (1860)	131	24000	R	400
GPC 12/200B	1200	-	1100	400 x 600 x 900	1930 x 1360 x 1380 (1930)	200	30000	R	518
GPC 12/300B	1200	-	1100	550 x 600 x 900	2080 x 1360 x 1380 (2080)	300	36000	R	600
GPC 12/350B	1200	-	1100	550 x 600 x 1050	2080 x 1360 x 1530 (2080)	350	39000	R	650
GPC 13/131B	1300	-	1200	350 x 500 x 750	1860 x 1260 x 1230 (1860)	131	24000	R	400
GPC 13/200B	1300	-	1200	400 x 600 x 900	1930 x 1360 x 1380 (1930)	200	30000	R	518
GPC 13/300B	1300	-	1200	550 x 600 x 900	2080 x 1360 x 1380 (2080)	300	36000	R	600
GPC 13/350B	1300	-	1200	550 x 600 x 1050	2080 x 1360 x 1530 (2080)	350	39000	R	650

i Please note:

- Heat up time is measured to 100°C below max, using an empty chamber
- Holding power is measured at continuous operating temperature

The following models GPC 12/36, GPC 13/36, GPC 12/65 & GPC 13/65 have been renamed CWF; see page 31 of the catalogue.

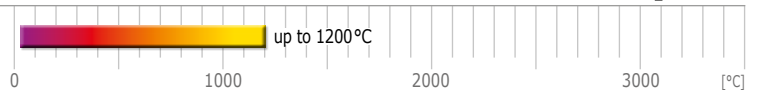

GPCMA - Modified Atmosphere Chamber Furnaces

Our GPCMA chamber furnaces are equipped with a metallic retort to provide a uniform heated volume with a controlled atmosphere. These floor-standing models have a smooth action double pivot door. Available with a range of maximum temperatures from 1000°C to 1200°C depending on the selected retort material. Retort working volumes range from 37 to 245 litres. Oxygen levels can be reduced to 30 ppm depending on the application. Perfect for stress relieving additive manufactured components particularly those produced via DMLS. This range of furnaces can be optionally specified for compliance to AMS2750E Nadcap Class 1 for aerospace applications.

Applications

- Stress relieving 3D printed additive manufactured parts
- Pyrolysis
- Debinding



GPCMA/174 with semi automatic gas system with digital flowmeters and data logging options

Standard features

- A range of maximum temperatures dependent on retort material:
 - 310 Stainless Steel retort 1000°C maximum
 - 314 Stainless Steel retort 1050°C maximum
 - Inconel 601 retort 1100°C maximum
 - Haynes 230 retort 1150°C maximum
 - APMT retort 1200°C maximum
- Programmable 3508P1 controller
- 2-zone cascade control
- Over-temperature protection
- 37, 56, 117, 174, 208, or 245 litre retort volume
- Semi-automatic gas system with analogue flowmeters for nitrogen
- Free radiating coiled wire elements on two sides, the roof and under the hearth (37 litre: two sides and under hearth)
- Low thermal mass insulation for fast response & energy efficiency
- Smooth action double pivot door shields the user from excessive heat
- Type R control thermocouples
- Internal retort thermocouple: type K up to 1100°C, type N above 1100°C
- Silicone rubber water cooled door seal
- Door safety interlock

Options (specify these at time of order)

- Vacuum option (10^{-2} mbar) for faster atmosphere exchange **at room temperature only**. A vacuum retort **MUST** be ordered with this option
- Semi-automatic gas system with analogue flowmeters for argon
- Semi-automatic gas system with digital flowmeters (will be data logged if a data logger option is selected)
- Automatic gas system with gas monitoring and control with mass flow controllers
- Oxygen monitoring system with 3504 programmer
- Automatic forced cooling system
- Afterburner option (NOT compatible with vacuum option/vacuum retorts)
- Chiller unit, 5 litre/min, 1 kW.
- A range of sophisticated digital controllers, multi-segment programmers and data loggers is available. These can be fitted with RS232, RS485 or Ethernet communications (see pages 106 – 111)
- AMS2750E Nadcap compatible models are available
- Various loading and unloading options can be supplied

Cool down rates for GPCMA/174

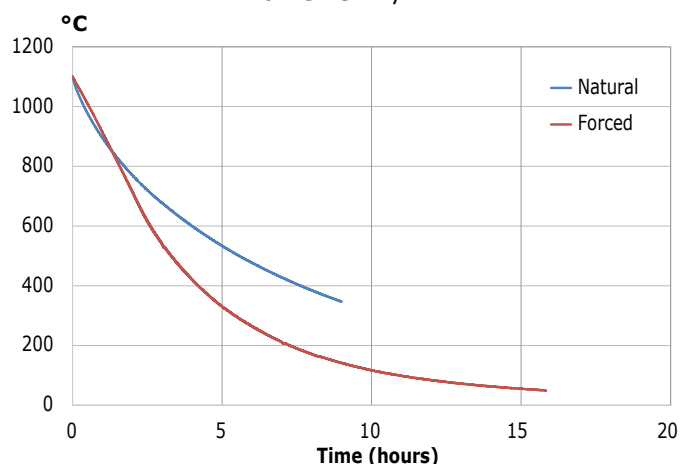

GPCMA retort internal dimensions

Model	Height h/H [mm]	Width W [mm]	Depth [mm]
GPCMA/37	205/230	337	538
GPCMA/56	238/295	400	665
GPCMA/117	278/345	500	815
GPCMA/174	428/495	500	815
GPCMA/208	428/495	500	965
GPCMA/245	500/574	600	815

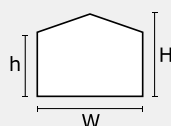

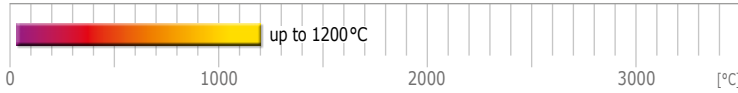

GPCH2 - Hydrogen atmosphere

The Carbolite Gero GPCH2 furnaces are designed specifically for use with a hydrogen atmosphere. The GPCH2 furnace range has the same retort capacities as the GPCMA furnace range and incorporates all the safety equipment required for safe use with hydrogen.

Please refer to the Carbolite Gero GPCH2 product range which is detailed in the 'Vacuum, Inert and Reactive Gas Furnaces catalogue'.



GPCH2

Furnace capacity for typical AM base plate sizes

Model	Retort capacity Plate size 350 x 250 x 250 (H x W x D) [mm]	Retort capacity Plate size 400 x 400 x 400 (H x W x D) [mm]
GPCMA/37	1 plate, max height 100 mm	Not applicable
GPCMA/56	1 plate, max height 150 mm	Not applicable
GPCMA/117	2 plates, max height 200 mm	1 plate, max height 200 mm
GPCMA/174	2 plates, max height 350 mm	1 plate, max height 350 mm
GPCMA/208	3 plates, max height 350 mm	2 plate, max height 350 mm
GPCMA/245	4 plates, max height 400 mm	1 plate, max height 400 mm



Temperature Uniformity

- Can achieve AMS2750E Class 1, instrument type B: $\pm 3^\circ\text{C}$

Temperature and atmosphere requirements for AM metals heat treatment

Carbolite Gero product range	Material	Temperature	Atmosphere
HTMA (see page 22)	Aluminium	500°C	Air or inert gas
GPCMA	Titanium	900°C - 1100°C	Argon
GPCMA	Tool Steel	900°C - 1100°C	Argon
GPCMA	Co/Cr	1150°C	Argon
GPCMA	Inconel 718	960°C & 1060°C Requires fast cooling to 200°C. (2-4 hrs)	Argon
GPCMA	Ti-6Al-4V	750°C - 950°C	Argon
GPCMA	Inconel 625	900°C	Argon
GPCMA	Copper alloys	900°C	Argon

Technical data

Model	Retort Volume [litres]	Max. temp with Retort	Dimensions (H x W x D) [mm]			Power [W]	Weight [kg]
			External Overall Size	Retort Internal Size	Uniform volume $\pm 5^\circ\text{C}$		
GPCMA/37	37	dependent on retort material	1990 x 900 x 1326	205 x 337 x 538	100 x 250 x 300	17000	220
GPCMA/56	56	dependent on retort material	1846 x 1260 x 1725	229 x 400 x 610	150 x 275 x 300	24000	485
GPCMA/117	117	dependent on retort material	1896 x 1360 x 1875	279 x 500 x 840	200 x 400 x 550	30000	608
GPCMA/174	174	dependent on retort material	2045 x 1360 x 1875	428 x 500 x 815	350 x 400 x 550	36000	705
GPCMA/208	208	dependent on retort material	2045 x 1360 x 2025	428 x 500 x 970	350 x 400 x 800	39000	800
GPCMA/245	245	dependent on retort material	2145 x 1460 x 2025	500 x 600 x 815	400 x 500 x 500	45000	950

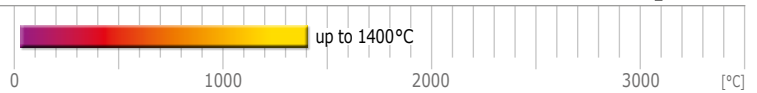

LCF – Large Chamber Furnaces

The robust construction of the LCF large chamber furnaces makes them ideal for applications such as the heat treatment of steels and alloy, ceramics sintering and aerospace heat treatment.

The LCF range is often customised in order to precisely meet the user's requirements. This range also provides a foundation upon which a wide range of custom modifications can be added. Typical examples include the more sophisticated control systems and data recording that is required for applications such as AMS2750E heat treatment under Nadcap. Solutions are available to handle heavier loads or assist in loading and unloading the furnace, or larger chamber sizes than are offered in the standard range.

Standard features

- 1200 °C & 1400 °C maximum temperatures
- Programmable 3216P1 controller
- Over-temperature protection
- Excellent temperature uniformity and control
- Robust construction using hollow steel section & zinc coated steel sheet
- Double skin construction ensures safe outer case temperature
- Manually operated vertically opening door keeps the hot face away from the operator
- Low thermal mass insulation for high energy efficiency
- Hard wearing silicon carbide tiled hearth
- 1200 °C range heated by heavy gauge wire elements in roof and below the hearth
- 1400 °C range heated by silicon carbide elements in roof and below the hearth
- Safety door interlock isolates power from the elements whenever the door is opened



Customised
3-zone LCF 12/560

Options (specify these at time of order)

- A range of sophisticated digital controllers, multi-segment programmers and data loggers is available. These can be fitted with RS232, RS485 or Ethernet communications (see pages 106 – 111)
- Pneumatically or electrically operated doors
- A range of retorts can be supplied for using modified atmospheres up to 1000 °C
- Remote control module
- Designs for compliance with AMS2750E (Nadcap) and other industry standards

Technical data

CGH	Max. temp. [°C]	Max. continuous operating temperature [°C]	Dimensions: Usable chamber H x W x D [mm]	Dimensions: External H x W x D [mm]	Volume [litres]	Max. power [W]	Thermocouple type
LCF 12/202	1200	1150	300 x 600 x 1120	2360 x 1280 x 1640	202	24000	R
LCF 12/405	1200	1150	450 x 750 x 1200	2560 x 1440 x 1750	405	35000	R
LCF 12/560	1200	1150	500 x 750 x 1500	2700 x 1500 x 2300	560	45000	R
LCF 12/675	1200	1150	500 x 750 x 1800	2700 x 1500 x 2600	675	60000	R
LCF 12/720	1200	1150	600 x 1000 x 1200	2950 x 1575 x 1810	720	60000	R
LCF 14/125	1400	1400	250 x 500 x 1000	2310 x 1340 x 1650	125	30000	R
LCF 14/350	1400	1400	400 x 760 x 1130	2545 x 1549 x 1800	350	48000	R
LCF 14/480	1400	1400	500 x 800 x 1200	2560 x 1650 x 1900	480	60000	R
LCF 14/725	1400	1400	500 x 720 x 1790	2620 x 1480 x 2470	725	60000	R

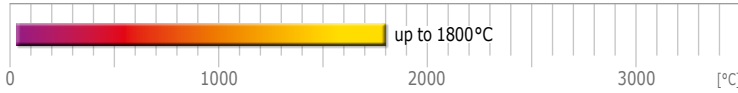

HB – Top Hat Furnaces

The HB furnace range has an automatically operated vertically moving hood for heat treatment in air.

The moving hood design allows samples to be accessed from three sides. The HB can be equipped with CrFeAl heating wires up to 1300 °C or with MoSi₂ heating elements for temperatures up to 1800 °C

The HB hood furnaces are available with usable volumes of 80 to 514 litres with the inner space being rectangular in design and the base plate having a convenient height of 750 mm. The hood moves up and down automatically to load and unload the sample.

All debinding applications require the use of an optional afterburner. The afterburner is driven by propane gas and compressed air to burn any evaporating binder. Carbolite Gero specializes in custom designed furnaces and can also create a customised version of the HB to accommodate specific heat treatment needs. It is possible to equip a gas circulating system to improve temperature uniformity. Several sample thermocouples can be inserted into the furnace chamber to monitor and test the temperature profile. Through the use of a serial interface, the thermocouple data is logged at predefined intervals for evaluation. The furnace is operated manually with a Eurotherm controller. Other controllers are available upon request.



HB 13/240

Standard features

- 1300 °C, 1600 °C, 1700 °C & 1800 °C maximum operating temperatures
- Carbolite Gero 3216CC controller with single ramp to set point and process timer
- From 80 to 514 litre capacities
- FeCrAl wire heating elements for temperatures below 1300 °C
- High quality molybdenum disilicide heating elements for temperatures above 1600 °C
- Advanced refractory interior, used in combination with energy efficient low thermal mass insulation

Options (specify these at time of order)

- A range of sophisticated digital controllers, multi-segment programmers and data loggers is available. These can be fitted with RS232, RS485 or Ethernet communications (see pages 106 – 111). Please note that special controllers may be needed for this model
- Over-temperature protection (recommended to protect valuable contents & for unattended operation)
- Other sizes on request
- Gas inlet for operation under modified atmosphere (not gas tight)
- Afterburner for debinding applications

Technical data

CGN	Max. temp. [°C]	Uniformity between 800 °C and T _{max} [°C] (DIN 17052)	Max. heat-up rate [°C/min]	Cooling time [h]	Dimensions: Usable chamber H x W x D [mm]	Dimensions: External H x W x D [mm]	Volume [l]	Max. power [kW]
HB_/80	1300, 1600, 1700, 1800	±5	5, 10, 10, 10	12, 14, 14, 14	500 x 400 x 400	2200 x 1200 x 1200	80	18, 45, 50, 60
HB_/160	1300, 1600, 1700, 1800	±5	5, 10, 10, 10	14, 14, 14, 14	500 x 800 x 400	2200 x 1800 x 1200	160	30, 80, 85, 90
HB_/240	1300, 1600, 1700, 1800	-	-	14	500 x 1200 x 400	2200 x 2200 x 1200	240	63, 65, 69, 75
HB_/430	1300, 1600, 1700, 1800	-	-	-	600 x 1200 x 600	2500 x 2200 x 1500	430	-
HB_/514	1300, 1600, 1700, 1800	-	-	-	780 x 1200 x 550	2700 x 2200 x 1400	514	-

i Please note:
- Maximum continuous operating temperature is 100 °C below maximum temperature

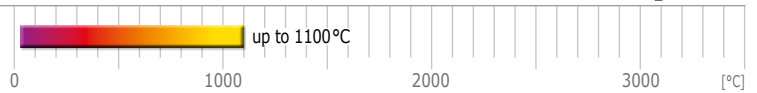

SBCF – Static or Bogie Hearth Chamber Furnaces

The robust construction of the SBCF large chamber furnace makes it ideal for applications such as the heat treatment of steels and alloys, ceramics sintering and aerospace heat treatment.

The SBCF chamber furnace is an industrial scale furnace based on a modular design principle which can be adapted to various applications. The furnace chamber is cubic in shape and is available in three sizes.

The furnace has a side hinged door and a fixed hearth. As an option the hearth can be fitted to a bogie so it can be pulled out of the furnace on a track system. This hearth design technique also allows the furnace to be easily adapted to a vertical lift arrangement to provide an elevator hearth, in which case the door would become a fixed side of the chamber.

Under hearth heating and free radiating coiled wire elements on four sides. This design provides the option of single and 3-zone temperature control and for applications demanding the best uniformity possible, such as AMS 2750E (this can be combined with an optional air circulation fan).

The construction uses low thermal mass insulation materials to maximise running efficiency whilst using robust refractory materials where physical strength is required such as the loading area of the hearth. Silicon carbide (SiC) tiles are fitted on the hearth to provide a hard wearing surface.



SBCF 11/1700

Options (specify these at time of order)

- Temperature interlocked door
- Bogie hearth
- Vertical air circulation fan
- Available with various instrumentation and data acquisition options

Standard features

- 1100°C maximum operating temperature
- Single zone models fitted with programmable 3508P1
- 3-zone models fitted with 1 x programmable 3508P1 and 2 x 3216CC slaves
- Retransmission of setpoint on 3-zone models
- Over-temperature protection

- Furnace can meet the requirements of AMS2750E
- Under hearth heating and free radiating coiled wire elements on four sides
- Excellent temperature uniformity and control
- Robust construction ensures safe outer case temperature
- Double skin construction ensures safe outer case temperature
- Hard wearing silicon carbide tiled hearth

Technical data

CGH Model	Zones	Max. temp. [°C]	Dimensions: External H (with fan / without fan) x W x D [mm]	Volume [litres]	Chamber size H x W x D [mm]	Uniform volume H x W x D [mm]	Temperature uniformity [°C]	Max. power [W]
Single Zone Static or Bogie Hearth Chamber Furnace								
SBCF-1/11/500	1	1100	2353/2130 x 1710 x 1354	512	800 x 800 x 800	600 x 600 x 600	±10	54000
SBCF-1/11/1700	1	1100	2753/2530 x 2110 x 1754	1728	1200 x 1200 x 1200	1000 x 1000 x 1000	±10	96000
SBCF-1/11/3300	1	1100	3053/2830 x 2410 x 2054	3375	1500 x 1500 x 1500	1300 x 1300 x 1300	±10	144000
3-Zone Static or Bogie Hearth Chamber Furnace								
SBCF-3/11/500	3	1100	2353/2130 x 1710 x 1354	512	800 x 800 x 800	600 x 600 x 600	±5	54000
SBCF-3/11/1700	3	1100	2753/2530 x 2110 x 1754	1728	1200 x 1200 x 1200	1000 x 1000 x 1000	±5	96000
SBCF-3/11/3300	3	1100	3053/2830 x 2410 x 2054	3375	1500 x 1500 x 1500	1300 x 1300 x 1300	±5	144000

i Please note:
 - Maximum continuous operating temperature is 100°C below maximum temperature



HRF – Air Recirculating Furnaces

The 750 °C HRF air recirculation furnaces comprise two bench-mounted models and two floor-standing models.

Equipped with powerful fans and horizontal air-guides these models are intended to provide rapid heating with high thermal transfer to the chamber contents and high uniformity within the chamber.

These designs frequently form the base from which custom designed chambers with non-standard sizes or control configurations are made. HRF ovens are often supplied with modifications to enable heat treatment within AMS2750E Nadcap compliant production environments.



HRF 7/22 with 3216P1 programmer and over-temperature options

Standard features

- 750 °C maximum operating temperature
- Carbolite Gero 301 controller, with single ramp to setpoint & process timer
- 22, 45, 112 or 324 litre chamber volumes
- Wire elements located in both sides of the chamber
- Stainless steel liner
- Combination of low thermal mass and refractory board insulation

Options (specify these at time of order)

- A range of sophisticated digital controllers, multi-segment programmers and data loggers is available. These can be fitted with RS232, RS485 or Ethernet communications (see pages 106 – 111)
- Over-temperature protection (recommended to protect valuable contents & for unattended operation)
- Additional sets of shelves & runners

Airflow in HRF

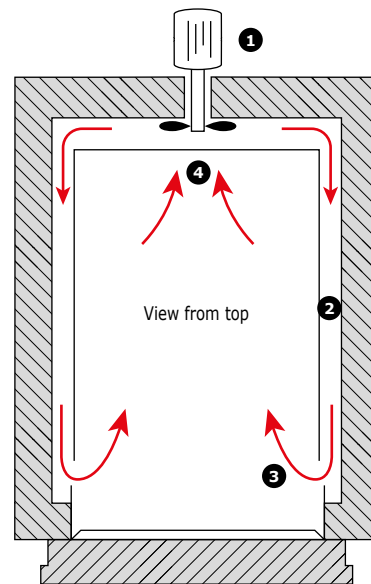

- 1) Air circulation fan
- 2) Heating elements heat the air
- 3) Heated air enters the chamber
- 4) Air from the chamber moves into the circulation fan

Technical data

Model	Max. temp. [°C]	Dimensions: Internal H x W x D [mm]	Dimensions: External H x W x D [mm]	Shelves fitted / accepted	Shelf loading each / total [kg]	Volume [litres]	Max. power [W]	Thermocouple type	Weight [kg]
HRF 7/22C	750	220 x 200 x 495	590 x 450 x 870 (Bench-top)	0 / 3	10 / 20	22	3000	K	61
HRF 7/45B	750	295 x 265 x 560	840 x 600 x 1000 (Bench-top)	0 / 3	10 / 20	45	6000	K	110
HRF 7/112	750	400 x 400 x 700	1550 x 1000 x 1600 (Floor-standing)	0 / 2	15 / 40	112	18000	K	480
HRF 7/324	750	600 x 600 x 900	1800 x 1200 x 2280 (Floor-standing)	1 / 1	50 / 50	324	24000	K	1000

i Please note:
 - External dimensions with door closed and including chimney
 - Heat up time is measured to 100°C below max, using an empty chamber

- Maximum power and heat up time based on a 240 V supply
 - HRF 7/22 and HRF 7/45 have 3 integral shelf runners

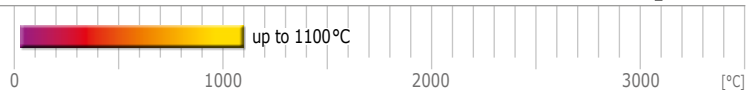

GLO – Annealing Furnaces

The GLO features a vacuum tight retort with symmetrical positioning of the heating elements. The heating elements are made of CrFeAl, also known as APM, and are embedded in ceramic fibre insulation.

The GLO furnaces have a compact, space saving design. They are often equipped with an optional vacuum pumping system to reduce the oxygen levels prior to heat treatment. To ensure the lowest possible contamination levels, several cycles of vacuum and nitrogen purging can take place to create a pure atmosphere in the retort. Vacuum assisted cycling is far superior to a simple flow of nitrogen through the retort as the process creates a pure atmosphere faster and requires less nitrogen. After oxygen levels have been reduced heat treatment begins under an inert atmosphere with a slight overpressure.

The front door of the cylindrical retort can be heated if required. The purge gas enters the retort via the water cooled front door and is preheated by the radiation shields, which are located at the front of the chamber. The GLO is provided with a rear port for the expulsion of any gaseous by-products generated during the process. The GLO can be operated manually or with the use of the optional automated system.

The furnace may be operated with reactive gases such as hydrogen, which requires appropriate optional safety technology. The hydrogen safety system includes an automatic operating system with a nitrogen purging tank to detect and purge the system should any malfunctions be detected. All devices are SIL2 certified.

The optional debinding package allows debinding or pyrolysis processes to be carried out. Virtually no condensation occurs as the unit is equipped with an afterburner and heated gas outlet for strong outgassing applications.

The GLO can be equipped with an optional fast cooling system. The retort can be air cooled from the outside or purged with cold, inert gas.

Standard features

- Manual control
- Two heating zones
- Gas tight retort made of 1.4841 (equals grade 314) stainless steel for highest vacuum possible
- Water cooled door with gas tight rubber sealing (water cooling must be provided at customer site)
- Radiation shields
- Gas control with manual control for a single inert gas, air or formation gas
- Precisely controlled atmosphere with highest possible purity



GLO 10/11-1G:
Compact hot wall furnace with stainless steel retort and optional inconel retort (vacuum up to 750°C and under normal pressure up to 1100°C)

Options (specify these at time of order)

- A range of sophisticated digital controllers, multi-segment programmers and data loggers is available. These can be fitted with RS232, RS485 or Ethernet communications (see pages 106 – 111). Please note that special controllers may be needed for this model
- Over-temperature protection (recommended to protect valuable contents & for unattended operation)
- Complete automation using Siemens SPS control with touch panel and mass flow controller for the gases
- Controls for multiple gases
- Charging racks
- Other retort sizes on request
- Other retort material e.g. Inconel or quartz glass
- Fast cooling system
- Water cooled coolings traps for volatile chemicals
- Vacuum pumps
- Gas packages for explosive or dangerous gases e.g. pure hydrogen with comprehensive safety features
- Debinding package with propane gas fired afterburner
- Heated front door
- Heated gas outlet
- Fan inside the retort for better uniformity at lower temperatures
- Water chiller for water cooling system if cooling water is not available at customer site

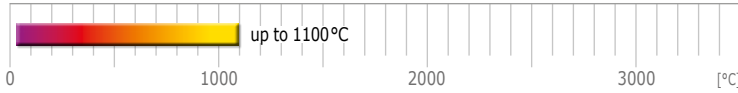

GLO – Annealing Furnaces

The maximum temperature of the GLO is 1100°C. In this temperature range, heat is transmitted via a high amount of heat convection and conduction. To ensure excellent temperature uniformity, the GLO can optionally be equipped with a gas circulation system by means of a fan located at the rear of the furnace, which ensures that the sample is surrounded by uniform inert gas at all times. The sample specimen is placed on an optional, horizontal charging rack with the incoming gases guided across the sample. Any gaseous by-products generated are immediately flushed out of the furnace. An optional probe thermocouple can be positioned at the rear of the furnace and in close proximity to the samples. The probe thermocouple may serve as the cascade thermocouple for the two heating zones of the GLO, and simultaneously, monitors the temperature directly at the sample. The heating elements are located outside the retort. An optional over-temperature thermocouple is used for unattended operation. Further thermocouple probes may be integrated into the retort upon request.

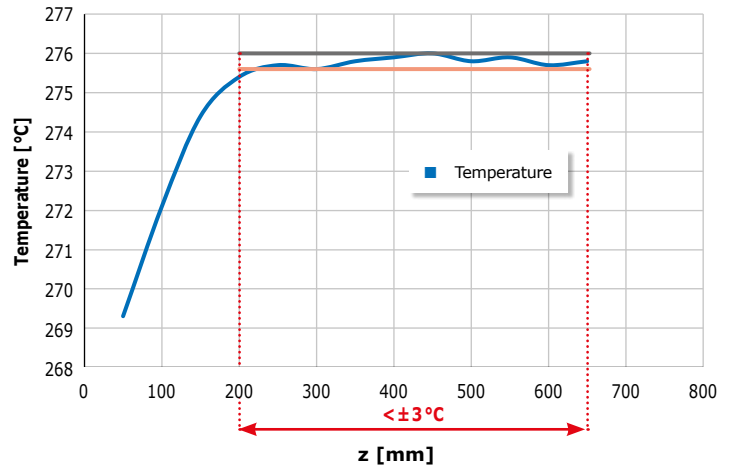

Temperature uniformity of the GLO

The graph shows the temperature of the empty GLO 75/09 along the symmetry axis. The evaluation of the temperature uniformity between 200 mm and 650 mm yields a maximum temperature deviation, which is better than $\pm 3^\circ\text{C}$. This uniformity is achieved by the symmetrical arrangement of the heating elements around the retort.

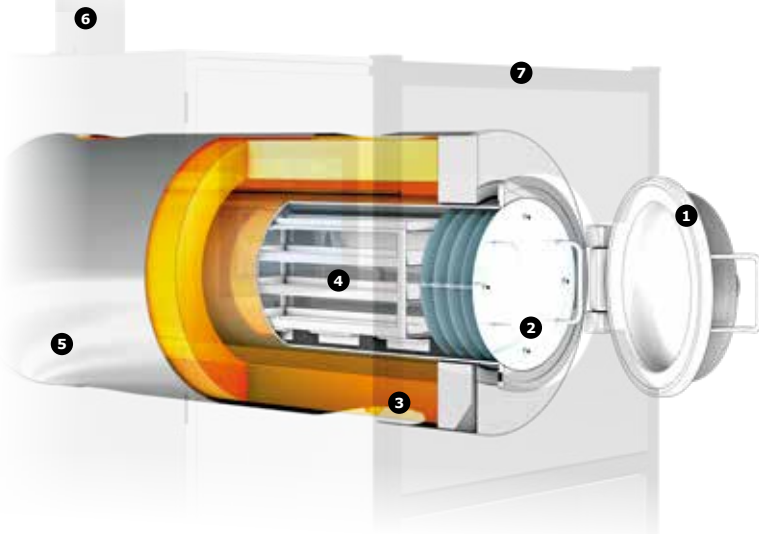

View inside

- 1) Open door
- 2) Radiation shields
- 3) Ceramic fibre insulation and heating elements
- 4) Charging rack
- 5) Thin metallic surrounding
- 6) Afterburner
- 7) Frame

Technical data

CGN Model	Max. temp. at atmospheric pressure [°C]	Max. temp. under vacuum [°C]	Uniformity between 300°C and 1100°C [K] (DIN 17052)	Max. heat-up rate [°C/min]	Cooling time [h]	Dimensions: Internal Ø x D [mm]	Dimensions: External H x W x D [mm]	Volume [l]	Max. power [W]	Transport weight Complete system [kg]
VGLO Toploader 10/11-1G	600, 900, 1100	600 (1.4841), 750 (Inconel)	±3	10	4-6	250 x 300 (height)	1600 (open) x 1400 x 850	10	14000	500
GLO 10/11-1G	600, 900, 1100	600 (1.4841), 750 (Inconel)	±3	10	4-6	250 x 300	1800 x 850 x 1600	10	14000	500
GLO 40/11-1G	600, 900, 1100	600 (1.4841), 750 (Inconel)	±3	10	7-9	300 x 600	1900 x 1400 x 1800	40	25000	1200
GLO 75/11-1G	600, 900, 1100	600 (1.4841), 750 (Inconel)	±3	10	7-9	400 x 600	2000 x 1600 x 1800	75	40000	1500
GLO 120/11-1G	600, 900, 1100	600 (1.4841), 750 (Inconel)	±5	10	8-10	500 x 700	2100 x 1800 x 2000	120	60000	2000

i Please note:
- Maximum continuous operating temperature is 100°C below maximum temperature

One of the most common applications for laboratory furnaces is to heat combustible samples in order to analyse the ash residue. As there is no single solution for all requirements, Carbolite Gero offers a range of furnaces with characteristics tailored to ashing and burn-off applications.

There are several important factors to consider, which will help to identify the correct furnace for successful ashing:

- Does the ashing process have to conform to a given test method, e.g. ISO/ASTM or other published standard?
- Does the ashing / burn-off process generate aggressive fumes which could damage the furnace or be hazardous?
- Will the furnace provide an adequate airflow to fully combust the sample?
- How large are the samples which must be ashed in order to provide a sufficiently large residue of ash for analysis?
- How intensive is the work cycle and how many samples must be processed?
- Would contamination of the ash with traces of alumina or silica (from conventional insulation materials) be detrimental?

Guide to ashing furnace selection

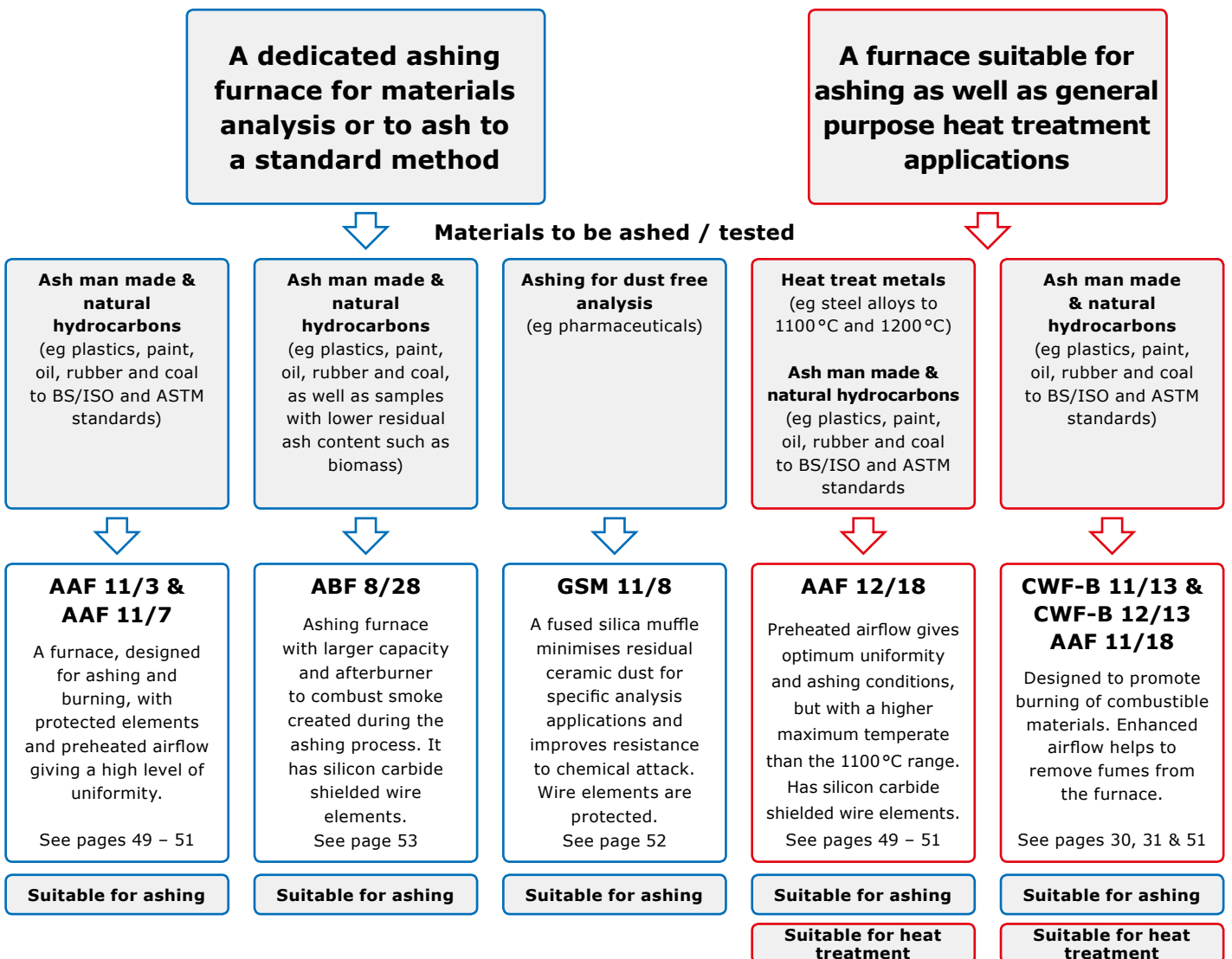

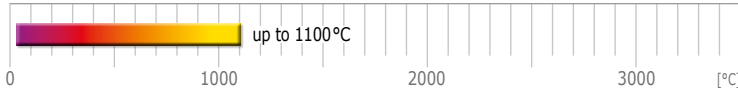

AAF – Standard Ashing Furnaces

The range of AAF ashing furnaces is designed specifically to provide optimum ashing conditions to ensure complete combustion of the sample.

The AAF 11/3 & AAF 11/7 ashing furnaces provide a continuous flow of preheated air through the chamber, and are designed to comply with ISO 1171:2010, ASTM D3174-04: 2010 and ASTM D4422.

Standard features

- 1100°C maximum operating temperature
- Carbolite Gero 301 single ramp to setpoint & process timer
- Large floor area allows for large number of samples
- Ideal for ashing foods, plastics, coal & other hydrocarbon materials
- Designed to comply with ISO 1171:2010, ASTM D3174-04: 2010 and ASTM D4422
- Wire elements are protected from chemical & mechanical damage by a hard wearing alumina based liner
- 4 sided heating (2 sides, roof & hearth)
- Air inlet & tall chimney give airflow of 4 to 5 changes per minute
- Low chamber height holds airflow close to samples for optimum combustion
- Powerful elements with graded winding compensate for heat loss due to high airflow
- Preheating of air before it enters the chamber gives excellent uniformity
- Sample tray and loading handle



AAF 11/3 and AAF 11/7

AAF 11/3 and AAF 11/7:

Airflow

- 1) A tall 50 mm diameter chimney (AAF 11/7), or 35 mm on AAF 11/3, pulls the air through the chamber
- 2) Preheated air enters the chamber after circulating around the outside of the chamber
- 3) Air inlet

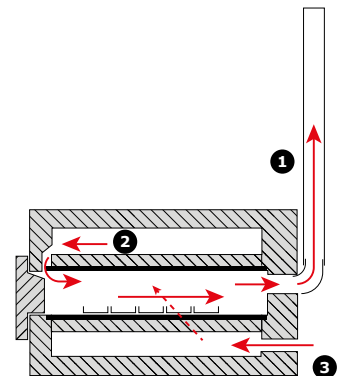

Options (specify these at time of order)

- 2 phase electrical supply for AAF 11/7
- A range of sophisticated digital controllers, multi-segment programmers and data loggers is available. These can be fitted with RS232, RS485 or Ethernet communications (see pages 106 – 111)
- Over-temperature protection (recommended to protect valuable contents & for unattended operation)

Accessories

- 1) Tray, dimensions inside (WxD):
AAF 11/3: 133x210 mm
- 2) Tray, dimensions inside (WxD):
AAF 11/7: 163x330 mm
- 3) Loading handle

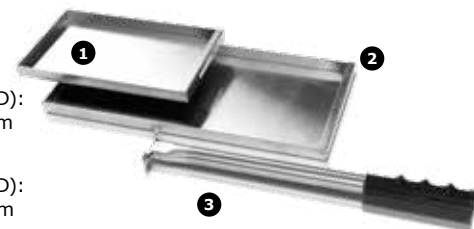

NEW Catalytic converter option

The thermal catalytic oxidiser option is suitable for applications where the exhaust gases are the result of organic reactions. Preheated air flows around and through the AAF chamber fueling combustion of the sample. The resulting gases or fumes are carried out of the chamber into the catalytic converter. Additional fresh air is drawn into the catalytic converter over an integral heater where the catalyst causes a chemical reaction to reduce the amount of fumes and unburnt volatiles.



AAF furnace + catalytic converter

- External dimensions:
AAF 11/3: 740 x 375 x 670 mm
AAF 11/32: 1600 x 690 x 900 mm
- External dimensions with door open:
AAF 11/3: 800 x 375 x 670 mm
AAF 11/32: 1600 x 690 x 900 mm
- Catalytic converter power supply requirements:
AAF 11/3: 250 W
AAF 11/32: 600 W

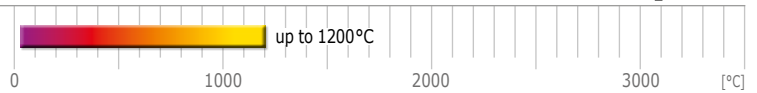

AAF – Standard Ashing Furnaces

The range of AAF ashing furnaces is designed specifically to provide optimum ashing conditions to ensure complete combustion of the sample.

For those laboratories where ashing is interspersed with other heat treatment work the AAF 12/18 provides all of the advantages of the AAF design, but with a higher maximum operating temperature of 1200°C.

Standard features

- 1100°C & 1200°C maximum operating temperatures
- Carbolite Gero 301 single ramp to setpoint & process timer
- Two tier rack system doubling the sample capacity with sample trays and loading handle allows for large number of samples
- Ideal for ashing foods, plastics, coal & other hydrocarbon materials
- Preheating of air before it enters the chamber
- Protection of the elements from carbon build-up or corrosive atmosphere, using silicon carbide tiles
- 2 sided heating



AAF 11/18

AAF 11/18, AAF 12/18,
AAF 11/32, AAF 12/32:

Airflow

- 1) Air inlet – air is preheated before entering the chamber
- 2) Plenum – a small amount of air flows between the heating elements and SiC side walls, to clear any fumes away from the elements. This combines with the chamber exhaust in the plenum.
- 3) Chimney
- 4) Two tier rack and trays

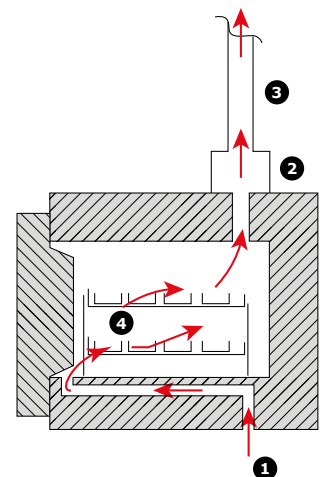

Accessories

- 1) AAF 11/18 & AAF 12/18 two tier rack system
- 2) Perforated tray, dimensions inside (WxD):
AAF __/18: 163x330 mm
AAF __/32: 230x400 mm
- 3) Loading handle

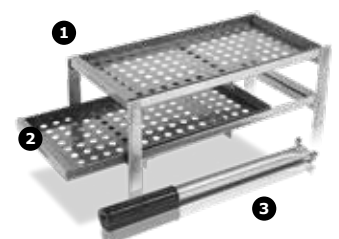

Options (specify these at time of order)

- A range of sophisticated digital controllers, multi-segment programmers and data loggers is available. These can be fitted with RS232, RS485 or Ethernet communications (see pages 106 – 111)
- Over-temperature protection (recommended to protect valuable contents & for unattended operation)

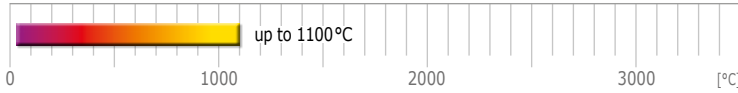

AAF-BAL - Ashing furnace with balance

The AAF-BAL furnace incorporates an integral balance. It can be used for loss on ignition applications where weight change of the sample must be monitored during the heating process.

The AAF-BAL ashing furnace is fitted with an integral balance and can be used for loss on ignition (LOI) applications. Weight change of the sample is monitored during the heating process and this is required, for example, in the determination of organic matter content in materials such as sediment, sludge, soil and waste. Inorganic materials such as cement, lime, calcinated bauxite and refractories can also be tested.



AAF-BAL 11/17

Standard features

- Carbolite Gero 301 single ramp to setpoint & process timer
- Protection of the elements from carbon build-up or corrosive atmosphere, using silicon carbide tiles
- 2 sided heating
- Balance runs independently of the furnace control system
- Maximum capacity of balance is 3 kg with a resolution of 0.01 g (other capacities available)

Options (specify these at time of order)

- Advanced version for 3508 to data-log both weight and temperature. It is also necessary to select the following options: 3508 instrument; either RS232, RS485 or Ethernet communication. Data logging is done via iTools software which must be purchased separately
- Advanced version for nanodac to data-log both weight and temperature. It is also necessary to select the following options: nanodac instrument. Data logging is done in the nanodac and can be downloaded into the 'Review Lite' software which is included with the nanodac
- A range of sophisticated digital controllers, multi-segment programmers and data loggers is available. These can be fitted with RS232, RS485 or Ethernet communications (see pages 106 – 111)
- Over-temperature protection (recommended to protect valuable contents & for unattended operation)

Technical data

CGH	Max. temp. [°C]	Heat-up time [mins]	Max. continuous operating temp. [°C]	Dimensions: Usable chamber H x W x D [mm]	Dimensions: External H x W x D [mm]	Dimensions: External with door open H x W x D [mm]	Dimensions: Height to top chimney [mm]	Volume [litres]	Max. power [W]	Holding power [W]	Thermo-couple type	Weight [kg]
AAF 11/3	1100	155	1000	90 x 150 x 250	585 x 375 x 485	800 x 375 x 485	780	3	2100	1270	K	22
AAF 11/7	1100	155	1000	90 x 170 x 455	650 x 430 x 740	905 x 430 x 740	1060	7	4000	2624	K	63
AAF 11/18	1100	70	1000	235 x 196 x 400	705 x 505 x 675	990 x 505 x 675	990	18	7080	3500	K	70
NEW AAF 11/32	1100	-	1000	250 x 280 x 450	820 x 690 x 730	1050 x 690 x 730	1200	32	9000	-	K	100
AAF 12/18	1200	70	1100	235 x 196 x 400	705 x 505 x 675	990 x 505 x 675	990	18	7080	3500	R	70
NEW AAF 12/32	1200	-	1100	250 x 280 x 450	820 x 690 x 730	1050 x 690 x 730	1200	32	9000	-	R	100
AAF-BAL 11/17	1100	-	1000	215 x 196 x 400	705 x 505 x 675 (400 x 170 x 500)*	990 x 505 x 675 (400 x 170 x 500)*	990	17	7080	3500	K	70

i Please note:

- Holding power is measured at 500°C
- Heat up time is measured to 100°C below max, using an empty chamber

- Maximum power and heat up time based on a 240 V supply
- *Dimensions of control box

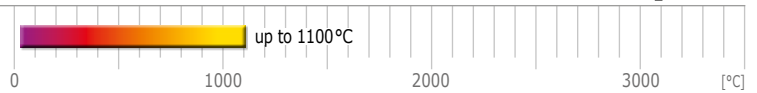

GSM – Specialist Ashing Furnace

Some analysis techniques may be affected by alumina or silica dust (Al_2O_3 and SiO_2) – the materials normally used to construct furnace chambers. To avoid this the GSM furnace chamber is constructed from a fused quartz material.

This design also offers superior containment of aggressive and corrosive vapours such as sulphuric, nitric and hydrochloric acids by keeping them away from the heating elements.

Additionally if an optional gas inlet is specified, the enclosed design minimises gas leakages from the chamber.

Standard features

- 1100°C maximum operating temperature
- Carbolite Gero 301 single ramp to setpoint & process timer
- Fused quartz furnace chamber, ideal for analyses where Al_2O_3 and SiO_2 could contaminate test results
- Chamber lining offers superior containment of corrosive & aggressive vapours such as H_2SO_4 , HNO_3 , HCl
- 4 sided heating (2 sides, roof & hearth)
- Moulded ceramic fibre door plug



GSM 11/8

Options (specify these at time of order)

- A range of sophisticated digital controllers, multi-segment programmers and data loggers is available. These can be fitted with RS232, RS485 or Ethernet communications (see pages 106 – 111)
- Over-temperature protection (recommended to protect valuable contents and for unattended operation)
- Gas inlet for modified atmospheres (the fused quartz liner provides improved containment)
- Sample trays & racks

Airflow in GSM

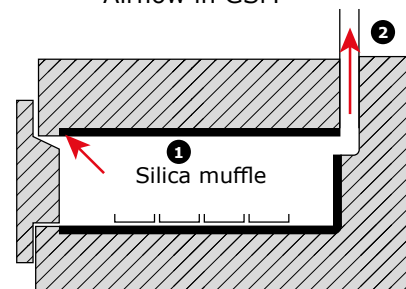

- 1) Quartz silica muffle protects the heating elements
- 2) Chimney vents fumes from the chamber

Technical data

Model	Max. temp. [°C]	Heat-up time [mins]	Max. continuous operating temperature [°C]	Dimensions: Usable chamber H x W x D [mm]	Dimensions: External H x W x D [mm]	Dimensions: External with door open H x W x D [mm]	Dimensions: Height to top chimney [mm]	Volume [litres]	Max. power [W]	Holding power [W]	Thermocouple type	Weight [kg]
GSM 11/8	1100	70	1000	120 x 175 x 345	655 x 435 x 750	895 x 435 x 750	1060	8	2950	1700	K	57

i Please note:

- Heat up time is measured to 100°C below max, using an empty chamber
- Holding power is measured at continuous operating temperature

- Maximum power and heat up time based on a 240 V supply
- The maximum depth to accommodate the door opening arc is 810 mm



ABF – Afterburner Ashing Furnace

The ABF afterburner ashing furnace is particularly suitable for ashing larger samples or materials such as biomass, which are likely to generate substantial amounts of smoke.

The furnace comprises a large main combustion chamber equipped as standard with a two tier set of sample baskets. The exhaust from the main chamber passes through a high temperature afterburner designed to further process fumes and smoke.

Standard features

- 800 °C maximum operating temperature – ashing chamber
- 3216P1 programmable controller
- 28 litre chamber volume
- Afterburner rated for up to 40 g carbon per ashing load
- Two tier baskets with loading tray and handle
- Independent control of afterburner temperature up to 950 °C
- Silicon carbide shielded wire wound elements
- Supplied with 3-phase supply as standard



ABF 8/28

Airflow in ABF 8/28

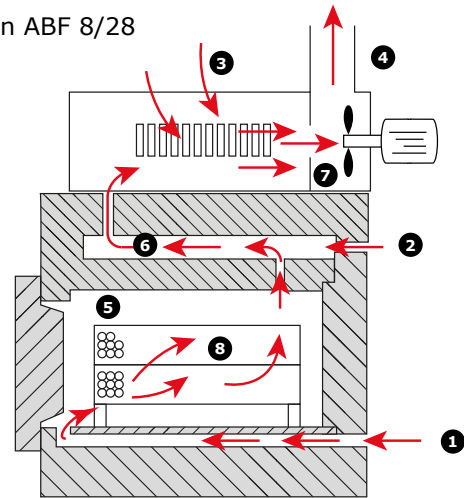

- 1) Air inlet – air is preheated before entering the chamber
- 2) Air inlet into afterburner to ensure complete combustion
- 3) Air inlet into plenum to cool the gases before entering the extraction fan
- 4) Chimney
- 5) Furnace chamber
- 6) Afterburner
- 7) Extraction fan
- 8) Two tier perforated basket system

Options (specify these at time of order)

- A range of sophisticated digital controllers, multi-segment programmers and data loggers is available. These can be fitted with RS232, RS485 or Ethernet communications (see pages 106 – 111)
- Over-temperature protection (recommended to protect valuable contents & for unattended operation)
- Optional floor stand

Technical data

CGH Model	Max. temp. [°C]	Max. continuous operating temperature [°C]	Dimensions: Usable chamber H x W x D [mm]	Dimensions: External H x W x D [mm]	Dimensions: Height to top chimney [mm]	Volume [litres]	Max. power [W]	Holding power [W]	Thermocouple type	Weight [kg]
ABF 8/28	800	700	210 x 290 x 445	980 x 600 x 750 (Bench-top or optional stand)	1150	28	8000	3828	K	120

- i** Please note:
- Holding power is measured at 500 °C
 - Heat up time is measured to 100 °C below max, using an empty chamber
 - External dimensions with door closed

Horizontal & Vertical Tube Furnaces up to 2600 °C

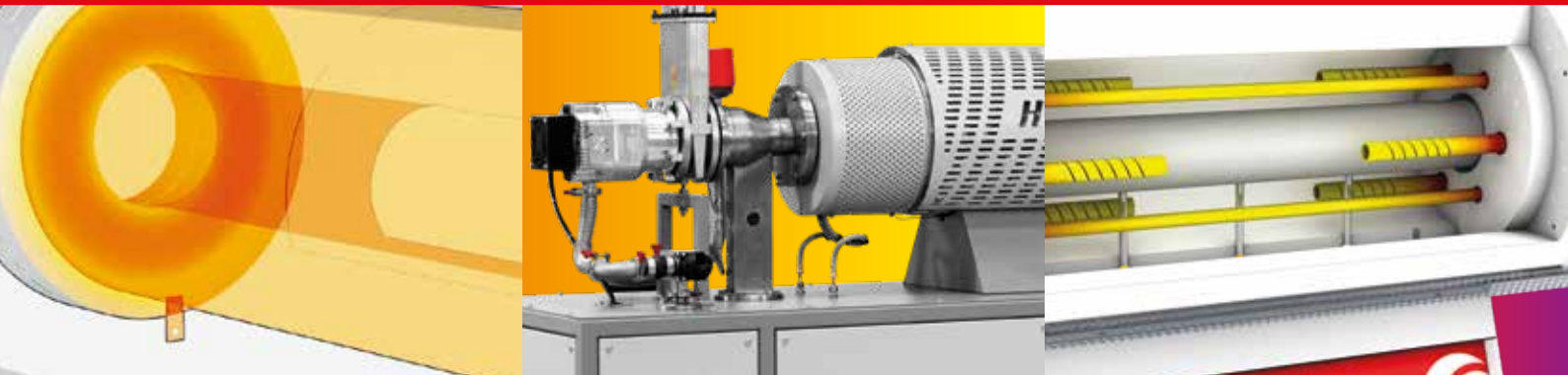

Tube Furnaces	Models	Page
Tube Furnaces Selection Guide		56
Universal Tube Furnaces	MTF, CTF, TZF, EHA, EHC, EVA, EVC, GHA, GHC, GVA, GVC, FHA, FHC, AZ, STF, TZF, HTRH, HTRV, HTRH-GR	58
Split Tube Furnaces	EST, EZS, EVT, EVZ, HST, HZS, VST, TVS, KVZ, KZS, FST, FZS, HTRV-A, HTR, RHST, RHZS	74
Gradient Tube Furnaces	AZ, HZS-2G, EZS-3G	88

Tube furnaces are frequently the most economical way to heat a small sample. Rapid temperature changes are possible by simply adding a push-rod to move the sample along the length of the tube (although care must be taken not to cause thermal shock to the tube or sample boat). Additionally, the use of a tube furnace makes controlling the temperature uniformity and atmosphere around the specimen easier.

Carbolite Gero's design features optimised uniform zone



The selection of a tube furnace should take into account the following factors:

What temperature?

- It is recommended to allow at least 100 °C extra heating range above the desired working temperature
- Standard models are available with maximum operating temperatures from 1000 °C to 1800 °C
- Different heating technologies are utilised to achieve each given temperature range

Size & work tubes?

- Some furnaces, most often those with wire wound elements, are supplied with an integral work tube, usually because the resistance wire element is wound directly onto the work tube
- For some tube furnaces an accessory work tube is essential
- An accessory work tube may be preferred either because of its material properties or to protect (where there is one) the wire wound work tube
- See the 'work tube' section (pages 112–113) for advice on selecting the correct work tube

Single or 3-zone?

- Tube furnaces provide a high level of uniformity which may be required for applications that require a specific temperature uniformity (see image top right showing typical optimised uniform length).
- The length of the central uniform zone can be further increased by adding heated zones at the ends in the form of a 3-zone furnace design
- For temperature gradients see page 88

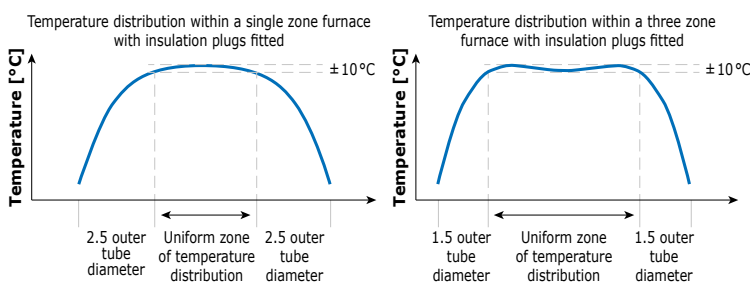

Modified atmosphere or vacuum?

- Tube furnaces are ideal when the sample must be heated in an inert atmosphere or a vacuum
- Work tube packages for use with inert, vacuum and hydrogen atmospheres are available (pages 114–115)
- A choice of rotary vane or turbomolecular vacuum pump packages is available (page 118)

Horizontal or vertical?

- Most Carbolite Gero tube furnaces are available in horizontal and vertical configurations
- When used vertically, insulation plugs or radiation shields are strongly recommended to minimise the effects of convection currents through the work tube
- In vertical configurations the furnace body is separate from the control module and attached by a 2 metre conduit

Split tube models

- Both vertical and horizontally configured furnaces are available with the furnace body split and hinged along its length
- This enables easy access where work tubes are to be changed between jobs or where the furnace is to be wrapped around the sample for example in tensile test rigs

Application specific & bespoke designs

Rotary reactor, elevator tube and high vacuum tube furnaces are just some of the standard variations of tube furnaces available from Carbolite Gero. Many other bespoke modifications can be provided offering alternative temperature ranges, dimensions, physical configurations, sample handling and functionality such as rotating tubes. Simply contact Carbolite Gero or your local distributor for a quotation.

Mounting Configurations

Non-split tube furnaces

The standard configuration for the MTF, CTF, STF, GHA, GHC, EHA, EHC and TZF horizontal tube furnaces is for the furnace body to be mounted directly onto a control module.

Other options are available at time of order.

The furnace body can be mounted on a 'blanked base' linked via a 2 or 6 metre power conduit to a separate control module.

The furnace body can be supplied mounted on a separate 'L' stand which allows it to be freely positioned separately from the control module in either a horizontal or vertical position. Note that different work tube mounting accessories may be required to change from horizontal to vertical operation, or vice versa.

The furnace body may be supplied separately from the base and either completely without a stand or with a wall mounting bracket.

GVA and GVC are "versatile" models with a stand kit for vertical, wall mounting or horizontal. They may be ordered without all or part of the stand kit as follows:

No Foot: Without the base (foot) of the stand - suitable for mounting to a horizontal or vertical surface.

No Stand: Without any of the stand kit components.

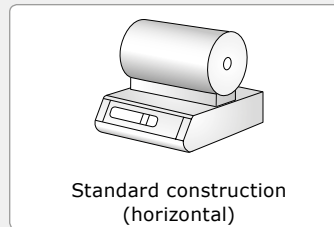

Standard construction (horizontal)

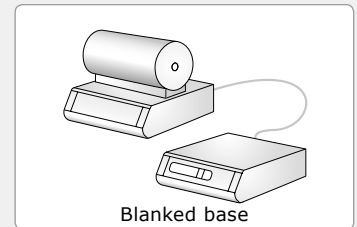

Blanked base

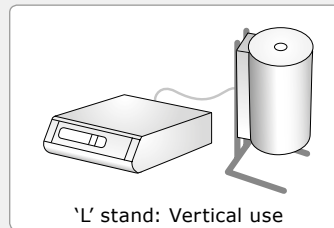

'L' stand: Vertical use

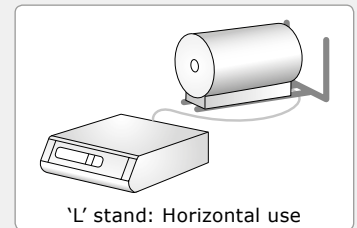

'L' stand: Horizontal use

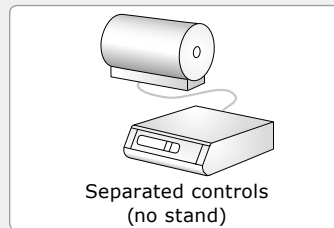

Separated controls (no stand)

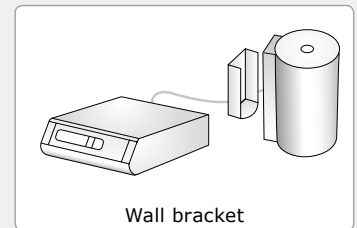

Wall bracket

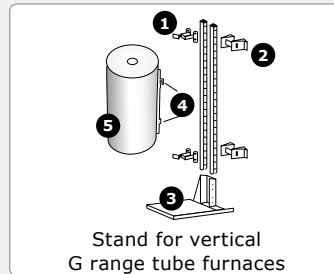

Stand for vertical G range tube furnaces

- 1) Horizontal support
- 2) Wall bracket
- 3) Foot
- 4) Support system
- 5) Body

Split tube furnaces

Split tube furnaces from the HST and HZS ranges are optionally available for dual vertical and horizontal use mounted upon an 'L' stand. Split tube furnaces from the KST and KZS ranges are designed for horizontal use.

The KVT and KVZ models are designed for vertical use and are mounted upon an 'L' stand.

VST and TVS vertical split tube furnaces are similarly available without stands and in 'far-hinge' designs as an alternative to the standard 'near-hinge' configuration. The 'far-hinge' configuration opens wide to give easier access when using large work tubes or test pieces.

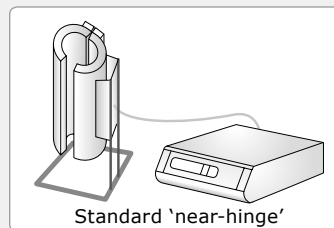

Standard 'near-hinge'

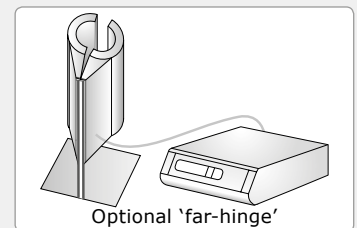

Optional 'far-hinge'

F range, HTRH & HTRV

The standard configuration for the FHA, FHC, FST, FZS, HTRH, HTRH-3, HTRV and HTRV-A furnaces consist of a separate furnace body in a rectangular housing and a separate control box. In case of the F range an optional separate 'L' stand allows it to be freely positioned in either a horizontal or vertical position. HTRH and HTRV models need to be ordered in the preferred position and cannot be switched between vertical and horizontal position.

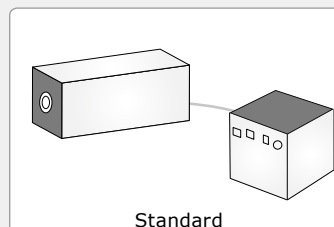

Standard

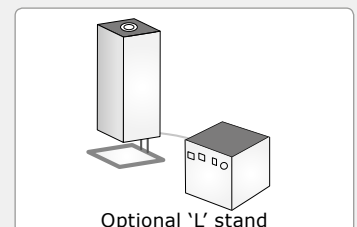

Optional 'L' stand

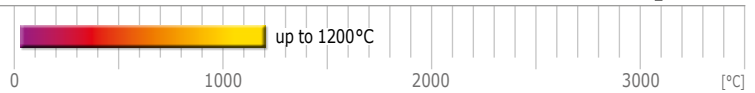

MTF – Small Tube Furnaces

The MTF wire wound tube furnaces use a wire element that is wound directly onto a fixed integral ceramic work tube.

This simple and economical design provides a furnace which can be used without the need to purchase an accessory work tube. However, should vacuum or a modified atmosphere be required, it is necessary to use a separate slide-in work tube in order to provide the required length needed to fit end seals. Similarly, in some circumstances a work tube that has different physical or chemical properties to the fixed work tube may be required. The use of an additional slide-in work tube protects the integral work tube and heating element



MTF 12/25/250

Standard features

- 1000 °C or 1200 °C maximum operating temperature
- Carbolite Gero 301 controller with single ramp to setpoint and process timer
- 15 mm, 25 mm or 38 mm inner diameters
- 130 mm, 250 mm, 400 mm or 850 mm heated length
- Integral wire wound work tube
- Delayed start / process timer function as standard
- Horizontal configuration mounted on control module

Options (specify these at time of order)

- A range of sophisticated digital controllers, multi-segment programmers and data loggers is available. These can be fitted with RS232, RS485 or Ethernet communications (see pages 106 – 111)
- Over-temperature protection (recommended to protect valuable contents & for unattended operation)
- A range of additional work tubes (pages 112 – 113), end seals (page 116) and work tube packages (pages 114 – 115) is available for use with modified atmosphere
- Insulation plugs & radiation shields to prevent heat loss & improve uniformity
- Alternative mounting configurations are available (see page 57)

Technical data

CGH	Max. temp. [°C]	Heat-up time [mins]	Max. continuous operating temperature [°C]	Dimensions: Fixed tube inner diameter [mm]	Dimensions: Heated length [mm]	Dimensions: External H x W x D [mm]	Dimensions: Furnace body length [mm]	Uniform length ±5°C [mm]	Max. power [W]	Holding power [W]	Thermocouple type	Weight [kg]
MTF 10/15/130	1000	5	900	15	130	360 x 200 x 240	150	30	400	100	K	3
MTF 10/25/130	1000	10	900	25	130	360 x 200 x 240	150	45	400	100	K	3
MTF 12/25/250	1200	15	1100	25	250	375 x 370 x 375	300	60	700	200	N	10
MTF 12/38/250	1200	25	1100	38	250	430 x 370 x 375	300	90	1000	300	N	15
MTF 12/25/400	1200	25	1100	25	400	375 x 450 x 375	450	100	1000	200	N	15
MTF 12/38/400	1200	25	1100	38	400	430 x 450 x 375	450	130	1500	300	N	17
MTF 12/38/850	1200	-	1100	38	850	430 x 900 x 375	900	500	2800	-	N	24

i Please note:

- Heat up rate when using an optional ceramic work tube must be limited to 5°C/min
- Heat up time is measured to 100°C below max, using an empty tube & insulation plugs
- Holding power is measured at continuous operating temperature

- Maximum power and heat up time based on a 240 V supply
- Uniform length ±5°C (mm): Uniform temperature lengths are measured with insulation plugs fitted

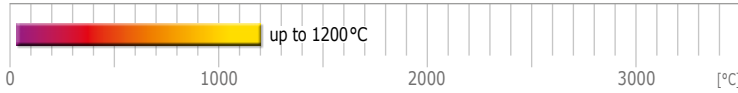

CTF, TZF – Large Tube Furnaces

The CTF single zone and TZF 3-zone wire wound tube furnaces use a wire element that is wound directly onto a fixed diameter integral ceramic work tube.

This simple and economical design of both the CTF and TZF provides a furnace that can be used without the need to purchase an additional work tube. However, should vacuum or a modified atmosphere be required, it is necessary to use a separate additional slide-in work tube in order to provide the required length needed to fit end seals. Similarly, in some circumstances a work tube that has different physical or chemical properties to the fixed work tube may be required.

The TZF heated length is divided into three zones. An extended uniform zone in the mid-section of the work tube is achieved with the use of end zone controllers which track the centre zone for temperature and compensate for the loss of heat from the tube ends. The use of an additional slide-in work tube protects the integral work tube for the TZF and heating element.



CTF 12/65/550 with 3216P1 programmer option

Standard features

- 1200°C maximum operating temperature
- Carbolite Gero 301 PID controller single ramp to setpoint and process timer
- 65 mm, 75 mm or 100 mm work tube inner diameters (CTF)
- 38 mm, 65 mm, 75 mm or 100 mm work tube inner diameters (TZF)
- 450, 550, 700, 850 or 900 mm heated length (varies with model)
- Integral wire wound work tube
- Delayed start / process timer function as standard (CTF)
- Horizontally mounted on control module base
- TZF provides a longer uniform zone than can be achieved in the CTF single zone tube furnace

Options (specify these at time of order)

- A range of sophisticated digital controllers, multi-segment programmers and data loggers is available. These can be fitted with RS232, RS485 or Ethernet communications (see pages 106 – 111)
- Over-temperature protection (recommended to protect valuable contents & for unattended operation)
- Alternative mounting options are available (see page 57)
- Optionally configured for 2 phase electrical supply
- A range of additional work tubes (pages 112 – 113), end seals (page 116) and work tube packages (pages 114 – 115) is available for use with modified atmosphere and/or vacuum
- Vacuum packages with a choice of rotary vane pump or turbomolecular pump are available for furnaces with tube inner diameters of 60 mm and above (page 118)
- Insulation plugs & radiation shields to prevent heat loss & improve uniformity
- Retransmission of Setpoint' control configuration to facilitate programmed cooling (TZF)

Technical data

CGH	Max. temp. [°C]	Heat-up time [mins]	Max. continuous operating temperature [°C]	Dimensions: Fixed tube inner diameter [mm]	Dimensions: Heated length [mm]	Dimensions: External H x W x D [mm]	Dimensions: Furnace body length [mm]	Uniform length ±5°C [mm]	Max. power [W]	Holding power (W)	Thermocouple type	Weight [kg]
Single Zone Large Tube Furnaces CTF												
CTF 12/65/550	1200	45	1100	65	550	530 x 625 x 360	600	230	2000	600	N	25
CTF 12/75/700	1200	45	1100	75	700	530 x 775 x 360	750	265	3000	800	N	28
CTF 12/100/900	1200	90	1100	100	900	530 x 975 x 360	950	455	4500	1000	N	35
3-Zone Large Tube Furnaces TZF												
TZF 12/38/400	1200	25	1100	38	400	430 x 450 x 375	450	305	1300	300	N	20
TZF 12/38/850	1200	-	1100	38	850	430 x 900 x 375	900	-	2850	-	N	27
TZF 12/65/550	1200	45	1100	65	550	530 x 625 x 360	600	390	2000	600	N	38
TZF 12/75/700	1200	45	1100	75	700	530 x 775 x 360	750	540	3000	800	N	46
TZF 12/100/900	1200	120	1100	100	900	530 x 975 x 360	950	754	4150	1000	N	54

Please note:

- Heat up rate when using an optional ceramic work tube must be limited to 5°C/min
- Heat up time is measured to 100°C below max, using an empty tube & insulation plugs
- Uniform length ±5°C (mm): Uniform temperature lengths are measured with insulation plugs fitted

- Maximum power and heat up time based on a 240 V supply
- Holding power is measured at continuous operating temperature

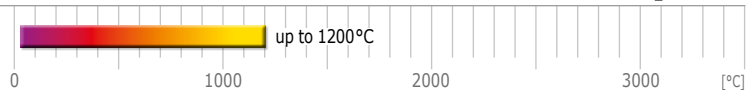

EHA, EHC, EVA, EVC – Compact Tube Furnaces

The compact EHA, EHC horizontal and EVA, EVC vertical compact tube furnaces use free radiating wire elements embedded within the insulation of the furnace body. The benefit of this design is its flexibility; with the use of tube adapters the same furnace can be used with a variety of tube diameters. The EHA and EVA are single zone furnaces and the EHC and EVC are three zone furnaces.

This range of tube furnaces does not include an integral work tube and one must be selected as an additional item. The work tube length is dependent on the application e.g. for use with modified atmosphere or vacuum; this information can be found on pages 112–113.

The use of a separate work tube has the advantage of protecting the heating elements from damage or contamination.



EHA 12/150 with CC-T1 temperature programmer

Standard features

- 1200°C maximum operating temperature
- Carbolite Gero 301 digital PID controller with single ramp to setpoint and process timer
- Heated lengths, single zone 150, 300, 450 or 600 mm (EHA, EVA)
- Heated lengths, 3-zone 450 and 600 mm (EHC, EVC)
- Accepts work tubes with outer diameters up to 60 mm
- Wire elements in high quality vacuum formed insulation ensure fast heat up, excellent temperature uniformity and short cool down times
- Horizontal configuration (EHA, EHC)
- Vertical configuration (can also be used horizontally – EVA, EVC)
- Control module with 2 metre conduit to furnace (EVA, EVC)
- Outer mesh guard ensures operator safety

Options (specify these at time of order)

- A range of sophisticated digital controllers, multi-segment programmers and data loggers is available. These can be fitted with RS232, RS485 or Ethernet communications (see pages 106–111)
- Over-temperature protection (recommended to protect valuable contents & for unattended operation)
- A range of additional work tubes (pages 112–113), end seals (page 116) and work tube packages (pages 114–115) is available for use with modified atmosphere and/or vacuum
- Vacuum packages with a choice of rotary vane pump or turbomolecular pump are available (page 118)
- Angle adjustment option allows horizontal and multi-angle configuration (EVA, EVC)
- Wide choice of tube diameters and materials is available. See pages 112–113 for tube materials and dimensions
- Insulation plugs and radiation shields to prevent heat loss and improve uniformity

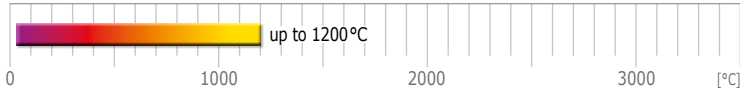

EHA, EHC, EVA, EVC – Compact Tube Furnaces



EVA 12/300
Angle adjustment option allows horizontal and multi-angle configurations

Technical data

Model	Max. temp. [°C]	Heat up time [mins]	Dimensions: Max. outer ø accessory tube [mm]	Dimensions: Heated length [mm]	Recommended tube length		Dimensions: External H x W x D [mm]	Uniform length ± 5°C [mm]	Max. power [W]	Thermocouple Type	Weight [kg]
					for use in air [mm]	for use with modified atmosphere [mm]					

Single Zone Horizontal Compact Tube Furnaces EHA

EHA 12/150B	1200	46	60	150	300	600	560 x 370 x 390	80	750	N	15
EHA 12/300B	1200	34	60	300	450	750	560 x 465 x 390	185	1480	N	17
EHA 12/450B	1200	44	60	450	600	900	560 x 615 x 390	300	2000	N	19
EHA 12/600B	1200	45	60	600	750	1050	560 x 765 x 390	460	2520	N	23

3-Zone Horizontal Compact Tube Furnaces EHC

EHC 12/450B	1200	55	60	450	600	900	560 x 615 x 390	335	2000	N	20
EHC 12/600B	1200	55	60	600	750	1050	560 x 765 x 390	470	2520	N	25

Single Zone Vertical Compact Tube Furnaces EVA

EVA 12/150B	1200	-	60	150	300	600	710 x 545 x 545	75	750	N	20
EVA 12/300B	1200	58	60	300	450	750	1040 x 545 x 545	180	1480	N	27
EVA 12/450B	1200	52	60	450	600	900	1040 x 545 x 545	250	2000	N	29
EVA 12/600B	1200	49	60	600	750	1050	1160 x 545 x 545	370	2520	N	33

3-Zone Vertical Compact Tube Furnaces EVC

EVC 12/450B	1200	58	60	450	600	900	1040 x 545 x 545	338	2000	N	30
EVC 12/600B	1200	58	60	600	750	1050	1160 x 545 x 545	455	2520	N	35

i Please note:

- Heat up rate when using an optional ceramic work tube must be limited to 5°C/min
- Heat up time is measured to 100°C below maximum, using an empty work tube and insulation plugs
- Holding power is measured at continuous operating temperature

- Maximum continuous operating temperature is 100°C below maximum temperature
- Dimensions excluding control box (225 x 370 x 390 mm)

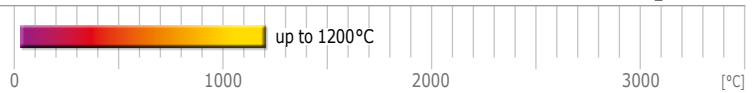

GHA, GHC – Modular Horizontal Tube Furnaces

The GVA and GHA single zone and GVC and GHC 3-zone tube furnaces use free radiating wire elements embedded within the insulation of the furnace body. The benefit of this design is its flexibility; with the use of tube adapters the same furnace can be used with a variety of tube diameters.

The extended uniform zone in the mid-section of the work tube in the GVC and GHC 3-zone furnace is achieved with the use of end zone controllers which track the centre zone temperature and compensate for the loss of heat from the tube ends. This range of tube furnaces does not include an integral work tube and one must be selected as an additional item. The work tube length is dependent on the application, for example, for use with modified atmosphere or vacuum. This information can be found on pages 112–113. The use of a separate work tube has the advantage of protecting the heating elements from damage or contamination.



GHA 12/300

Standard features

- 1200°C maximum operating temperature
- Carbolite Gero 301 digital PID controller with single ramp to setpoint, digital display and process timer
- Accepts work tubes with outer diameters up to 170 mm
- Heated lengths, single zone 300, 450, 600, 750, 900, 1050 or 1200 mm (GHA, GVA)
- Heated lengths, 3-zone 450, 600, 750, 900, 1050 or 1200 mm (GHC, GVC)
- Long life, rapid heating, resistance wire elements mounted in rigid, vacuum formed insulation modules
- Horizontal configuration (GHA, GHC)
- Furnace mounted directly on top of controller base unit (GHA, GHC)
- End zones 150 mm long on each end (GHC, GVC)
- End zone control via back to back thermocouples (GHC, GVC)
- Supplied with versatile stand for vertical, wall mounted and horizontal use (GVA, GVC)
- Control module with 2 metre conduit to furnace

Technical data

CGH Model	Max. temp. [°C]	Heat-up time [mins]	Max. continuous operating temp. [°C]	Dimensions: Max. outer Ø accessory tube [mm]	Dimensions: Heated length [mm]	Recommended tube length		Dimensions: External H x W x D [mm]	Dimensions: Furnace body length [mm]	Uniform length ±5°C [mm]	Max. power [W]	Holding power [W]	Thermo-couple type	Weight [kg]
						for use in air [mm]	for use with modified atmosphere [mm]							

Single Zone Modular Horizontal Tube Furnaces GHA

GHA 12/300	1200	90	1100	170	300	500	900	670 x 526 x 468	480	201	2300	1125	N	35
GHA 12/450	1200	75	1100	170	450	650	1050	670 x 676 x 468	630	262	3100	1555	N	37
GHA 12/600	1200	70	1100	170	600	800	1200	670 x 826 x 468	780	414	3900	1840	N	40
GHA 12/750	1200	80	1100	170	750	950	1350	670 x 976 x 468	930	448	4600	2165	N	51
GHA 12/900	1200	-	1100	170	900	1100	1500	670 x 1126 x 468	1080	-	5400	2800	N	55
GHA 12/1050	1200	67	1100	170	1050	1250	1650	670 x 1276 x 468	1230	696	6200	2960	N	85
GHA 12/1200	1200	83	1100	170	1200	1400	1800	670 x 1426 x 468	1380	-	7000	3310	N	90

3-Zone Modular Horizontal Tube Furnaces GHC

GHC 12/450	1200	75	1100	170	450	650	1050	672 x 676 x 468	630	300	3100	1551	N	37
GHC 12/600	1200	53	1100	170	600	800	1200	672 x 827 x 468	780	440	3900	1889	N	40
GHC 12/750	1200	62	1100	170	750	950	1350	672 x 976 x 468	930	500	4600	2200	N	51
GHC 12/900	1200	90	1100	170	900	1100	1500	672 x 1126 x 468	1080	640	5400	2800	N	55
GHC 12/1050	1200	67	1100	170	1050	1250	1650	672 x 1276 x 468	1230	880	6200	2850	N	85
GHC 12/1200	1200	61	1100	170	1200	1400	1800	672 x 1426 x 468	1380	-	7000	3163	N	90

i Please note:

- Heat up rate when using an optional ceramic work tube must be limited to 5°C/min
- Heat up time is measured to 100°C below max, using an empty tube & insulation plugs
- Uniform length measured with insulation plugs fitted

- Holding power is measured at continuous operating temperature

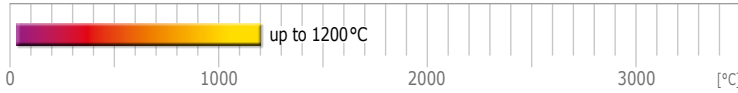

GVA, GVC – Modular Vertical Tube Furnace

Options (specify these at time of order)

- A range of sophisticated digital controllers, multi-segment programmers and data loggers is available. These can be fitted with RS232, RS485 or Ethernet communications (see pages 106 – 111)
- Over-temperature protection (recommended to protect valuable contents & for unattended operation)
- A range of additional work tubes (pages 112 – 113), end seals (page 116) and work tube packages (pages 114 – 115) is available for use with modified atmosphere and/or vacuum
- Vacuum packages with a choice of rotary vane pump or turbomolecular pump are available (page 118)
- Wide choice of tube diameters and materials is available. See pages 112 – 113 for tube materials and dimensions
- Available without stand (comprising control module & furnace body)
- Insulation plugs & radiation shields to prevent heat loss & improve uniformity
- End zones 300 mm long (GVC, GHC)
- Control module on longer 6 metre conduit (GVC)
- 'Retransmission of Setpoint' control configuration to facilitate programmed cooling
- Alternative mounting options are available (see page 57) (GHA, GHC)



GVA 12/600

Technical data

Model	Max. temp. [°C]	Heat-up time [mins]	Dimensions: Max. outer Ø accessory tube [mm]	Dimensions: Heated length [mm]	Recommended tube length		Dimensions: External Furnace body (inc. stand) H x W x D [mm]	Dimensions: Clearance under furnace H [mm]	Dimensions: Furnace body length [mm]	Uniform length ± 5°C [mm]	Max. power [W]	Hold-ing power [W]	Ther-mocouple type	Weight [kg]
					for use in air [mm]	for use with modified atmosphere [mm]								

Single Zone Modular Vertical Tube Furnaces GVA

GVA 12/300	1200	90	170	300	500	900	1345 x 468 x 662	251 to 778	480	-	2300	1125	N	73
GVA 12/450	1200	75	170	450	650	1050	1418 x 468 x 662	177 to 702	630	-	3100	1555	N	87
GVA 12/600	1200	70	170	600	800	1200	1418 x 648 x 662	177 to 550	780	-	3900	1840	N	95
GVA 12/750	1200	80	170	750	950	1350	1793 x 468 x 662	177 to 777	930	-	4600	2165	N	100
GVA 12/900	1200	-	170	900	1100	1500	1860 x 468 x 662	100 to 702	1080	-	5400	2800	N	110
GVA 12/1050	1200	67	170	1050	1250	1650	1943 x 468 x 662	26 to 627	1230	-	6200	2960	N	120
GVA 12/1200	1200	83	170	1200	1400	1800	2018 x 468 x 662	26 to 551	1380	845	7000	3310	N	130

3-Zone Modular Vertical Tube Furnaces GVC

GVC 12/450	1200	75	170	450	650	1050	1418 x 468 x 662	177 to 702	630	300	3100	1500	N	87
GVC 12/600	1200	80	170	600	800	1200	1418 x 468 x 662	177 to 550	780	440	3900	1800	N	95
GVC 12/750	1200	92	170	750	950	1350	1793 x 468 x 662	177 to 777	930	500	4600	2200	N	100
GVC 12/900	1200	111	170	900	1100	1500	1860 x 468 x 662	100 to 702	1080	640	5400	2281	N	110
GVC 12/1050	1200	122	170	1050	1250	1650	1943 x 468 x 662	26 to 627	1230	880	6200	2800	N	120
GVC 12/1200	1200	82	170	1200	1400	1800	2018 x 468 x 662	26 to 551	1380	1015	7000	3163	N	130

i Please note:

- Heat up rate when using a ceramic work tube must be limited to 5°C/min
- Heat up time is measured to 100°C below max, using an empty tube & insulation plugs
- Dimensions excluding control box (225 x 600 x 380 mm)

- Maximum continuous operating temperature is 100°C below maximum temperature
- Holding power is measured at continuous operating temperature
- Uniform length measured with insulation plugs fitted

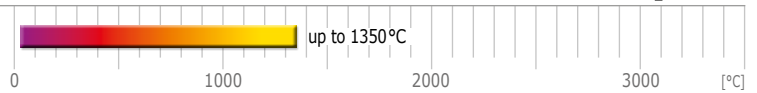

FHA, FHC – Horizontal and Vertical Tube Furnaces

The FHA, single zone, and FHC, 3-zone, tube furnaces can be used either vertically or horizontally and have a maximum operating temperature of 1350°C.

The extensive F range of tube furnaces is offered with a wide range of accessories. The furnaces comprise ceramic fibre modules with a high quality 5 mm APM wire heating element mounted in the insulation, held in position by a ceramic holding ridge. The low thermal mass ceramic fibre insulation ensures low energy consumption and allows fast heating rates. The control thermocouple is a high grade type S thermocouple. Additionally, the tube furnace is available with up to 8 heating zones for the most precise temperature control and uniformity.

Standard features

- 1350°C maximum operating temperature
- Single zone models fitted with Carbolite Gero 3216CC PID controller with single ramp to setpoint and process timer
- 3-zone models fitted with 1 x 3216CC and 2 x 3216CC end zone controllers, with retransmission of setpoint
- Accepts work tubes with outer diameters up to 110 mm
- Heated lengths of 200, 500, 750, 1000 or 1250 mm
- Use in horizontal or vertical orientation
- Exceptional lifetime and temperature stability
- High grade thermocouple type S
- Low thermal mass ceramic fibre insulation
- High quality 5 mm APM wire heating element
- Furnace fitted with separate control box with 3 m cable, plug and socket



FHA 13/80/500



Options (specify these at time of order)

- A range of sophisticated digital controllers, multi-segment programmers and data loggers is available. These can be fitted with RS232, RS485 or Ethernet communications (see pages 106 – 111). Please note that special controllers may be needed for this model
- Over-temperature protection (recommended to protect valuable contents & for unattended operation)
- Wide choice of tube diameters and materials is available. See pages 112 – 113 for tube materials and dimensions
- 'L' stand for vertical usage
- Insulation plugs & radiation shields to prevent heat loss & improve uniformity (see page 117)
- Modified atmosphere and vacuum assemblies are available (see page 117)
- Larger tube diameters on request
- Vacuum packages with a choice of rotary vane pump or turbomolecular pump are available (page 118)
- Oxygen sensor for inert gas packages



FHA 13/110/1000 with optional basic inert gas package and optional L-stand

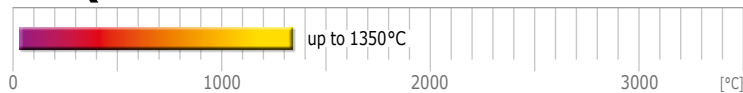

FHA, FHC – Horizontal and Vertical Tube Furnaces



FHA 13/80/500 with optional CC-T1 controller, voltage/current display and high vacuum capable inert gas package. Rotary vane pumps and turbo pumps available (see page 118)

Technical data

Tube furnace FHA (single zone) and FHC (three zones) both available in horizontal and vertical arrangement (with optional 'L' stand)

CGN	Max. temp. [°C]	Dimensions: Max. outer Ø accessory tube [mm]	Dimensions: Heated length [mm]	Recommended tube length		Dimensions: External furnace H x W x D [mm]	Furnace weight [kg]	Dimensions: Control module H x W x D* [mm]	Control module weight [kg]	Uniform length ± 5°C [mm]	Max. power [W]
				for use in air [mm]	for use with modified atmosphere [mm]						

Horizontal and Vertical Tube Furnaces (may need further equipment) FHA

FHA 13/32/200	1350	32	200	390	925	420 x 400 x 350	25	480 x 560 x 500	50	100	1200
FHA 13/32/500	1350	32	500	690	1225	420 x 700 x 350	30	480 x 560 x 500	50	250	2400
FHA 13/50/200	1350	50	200	390	925	420 x 400 x 350	30	480 x 560 x 500	50	100	1500
FHA 13/50/500	1350	50	500	690	1225	420 x 700 x 350	35	480 x 560 x 500	50	250	3600
FHA 13/50/750	1350	50	750	940	1475	420 x 950 x 350	40	850 x 560 x 500	60	375	5400
FHA 13/80/200	1350	80	200	390	925	420 x 400 x 350	35	480 x 560 x 500	50	100	2100
FHA 13/80/500	1350	80	500	690	1225	420 x 700 x 350	40	480 x 560 x 500	60	200	5200
FHA 13/80/750	1350	80	750	940	1475	420 x 950 x 350	50	850 x 560 x 500	70	375	7800
FHA 13/80/1000	1350	80	1000	1190	1725	420 x 1200 x 350	80	850 x 560 x 500	90	500	10400
FHA 13/110/500	1350	110	500	690	1225	590 x 700 x 520	55	850 x 560 x 500	70	250	7800
FHA 13/110/750	1350	110	750	940	1475	590 x 950 x 520	70	850 x 560 x 500	90	375	11500
FHA 13/110/1000	1350	110	1000	1190	1725	590 x 1200 x 520	100	1100 x 1200 x 700	90	500	16000
FHA 13/110/1250	1350	110	1250	1440	1975	590 x 1450 x 520	130	1100 x 1200 x 700	90	610	20000

3-Zone Horizontal and Vertical Tube Furnaces (may need further equipment) FHC

FHC 13/32/500	1350	32	500	690	1225	420 x 700 x 350	30	480 x 560 x 500	50	350	2400
FHC 13/50/500	1350	50	500	690	1225	420 x 700 x 350	35	480 x 560 x 500	50	350	3600
FHC 13/50/750	1350	50	750	940	1475	420 x 950 x 350	40	850 x 560 x 500	60	550	5400
FHC 13/80/500	1350	80	500	690	1225	420 x 700 x 350	40	480 x 560 x 500	60	350	5200
FHC 13/80/750	1350	80	750	940	1475	420 x 950 x 350	50	850 x 560 x 500	70	550	7800
FHC 13/80/1000	1350	80	1000	1190	1725	420 x 1200 x 350	80	850 x 560 x 500	90	800	10400
FHC 13/110/500	1350	110	500	690	1225	590 x 700 x 520	55	850 x 560 x 500	70	300	7800
FHC 13/110/750	1350	110	750	940	1475	590 x 950 x 520	70	850 x 560 x 500	90	500	11500
FHC 13/110/1000	1350	110	1000	1190	1725	590 x 1200 x 520	100	1100 x 1200 x 700	90	750	16000
FHC 13/110/1250	1350	110	1250	1440	1975	590 x 1450 x 520	130	1100 x 1200 x 700	90	950	20000

i Please note:

- Heat up rate when using an optional ceramic work tube must be limited to 5°C/min
- * Further to the depth of the control module 150 mm for the power plugs and other plugs needs to be added

- The power supply is based on 200 – 240 V for 1 phase and 380 – 415 V for 3 phase power
- Minimum uniform length in horizontal furnace with insulation plugs fitted at 100°C below max. temperature

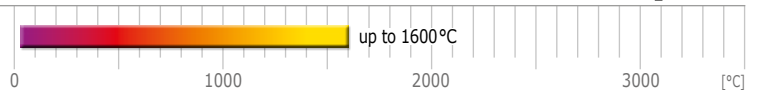

STF, TZF – High Temperature Tube Furnaces



STF 16/180



STF 15/610 with 3216P1 programmer and L stand option

The Carbolite Gero STF single zone and TZF 3-zone high temperature tube furnaces are available at 1500°C and 1600°C with both models using silicon carbide heating elements.

This range of tube furnaces does not include an integral work tube and one must be selected as an additional item. The work tube length is dependent on the application e.g. for use with modified atmosphere or vacuum. This information can be found on pages 112–113.

The TZF 3-zone high temperature tube furnace has heated lengths of 450 and 610 mm. An extended uniform zone in the mid-section of the work tube is achieved with the use of end zone controllers which track the centre zone temperature and compensate for the loss of heat from the tube ends.

Standard features

- 1500°C & 1600°C maximum operating temperatures
- Single zone models fitted with Carbolite Gero 301 PID controller with single ramp to setpoint and process timer
- 3-zone models fitted with 1 x programmable 3216P1 and 2 x 3216CC end zone controllers, with retransmission of setpoint
- Accepts work tubes up to 60 or 90 mm outer diameter depending on model
- Heated lengths, single zone 180, 450 or 610 mm (STF)
- Heated lengths, 3-zone 450 or 610 mm (TZF 15, TZF 16)
- Silicon carbide heating elements
- Horizontal configuration

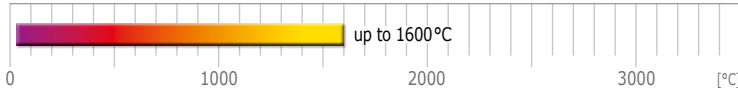

STF, TZF – High Temperature Tube Furnaces

Options (specify these at time of order)

- A range of sophisticated digital controllers, multi-segment programmers and data loggers is available. These can be fitted with RS232, RS485 or Ethernet communications (see pages 106 – 111)
- Over-temperature protection (recommended to protect valuable contents & for unattended operation)
- Alternative mounting options are available (see page 57)
- Optionally configured for 2 phase or 3 phase electrical supply (depending on model)
- A range of additional work tubes (pages 112 – 113), end seals (page 116) and work tube packages (pages 114 – 115) is available for use with modified atmosphere and/or vacuum
- Vacuum packages with a choice of rotary vane pump or turbomolecular pump are available (page 118)
- Insulation plugs & radiation shields to prevent heat loss & improve uniformity
- Control module with 2 metre conduit to furnace (TZF 15, TZF 16)
- Hook and strap work tube support (see page 116)

View inside



TZF 15/610 with CC-T1 programmer

- 1) Centre zone heating element
- 2) End zone heating elements
- 3) Control thermocouples
- 4) Thermal insulation
- 5) 3-zone temperature control
- 6) Work tube

Technical data

Model	Max. temp. [°C]	Heat-up time [mins]	Dimensions: Max. outer Ø accessory tube [mm]	Dimensions: Heated length [mm]	Recommended tube length		Dimensions: External H x W x D [mm]	Dimensions: Furnace body length [mm]	Uniform length ±5 °C [mm]	Max. power [W]	Holding power [W]	Thermo-couple type	Weight [kg]
					for use in air [mm]	for use with modified atmosphere [mm]							

Single Zone High Temperature Horizontal Tube Furnaces STF

STF 15/180	1500	-	60	180	600	900	625 x 600 x 375	600	80	2500	1600	R	29
STF 15/450	1500	-	90	450	900	1200	655 x 875 x 430	875	350	5500	3000	R	34
STF 15/610	1500	-	90	610	1200	1500	655 x 1080 x 430	1080	400	6000	4000	R	45

STF 16/180	1600	48	60	180	600	900	625 x 600 x 375	600	80	2500	1760	R	29
STF 16/450	1600	46	90	450	900	1200	655 x 875 x 430	875	350	6000	3300	R	40
STF 16/610	1600	-	90	610	1200	1500	655 x 1080 x 430	1080	400	7000	4500	R	50

3-Zone High Temperature Horizontal Tube Furnaces TZF

TZF 15/450	1500	-	90	450	900	1200	655 x 875 x 430	875	375	5060	3000	R	39
TZF 15/610	1500	75	90	610	1200	1500	655 x 1080 x 430	1080	450	8000	4000	R	70

TZF 16/450	1600	78	90	450	900	1200	655 x 875 x 430	875	393	6800	3300	R	39
TZF 16/610	1600	-	90	610	1200	1500	655 x 1080 x 430	1080	450	8000	4500	R	70

i Please note:
 - Heat up rate when using an optional ceramic work tube must be limited to 5°C/min
 - Heat up time is measured to 100°C below max, with no work tube fitted and with end plugs fitted

- Maximum continuous operating temperature is 100°C below maximum temperature
 - Uniform length measured with insulation plugs fitted.

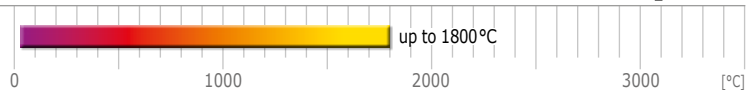

HTRH – High Temperature Horizontal Tube Furnaces

The Carbolite Gero high temperature tube furnaces HTRH can be used horizontally up to 1800°C.

The high-grade insulation materials guarantee low energy consumption and high heating rates due to their low thermal conductivity. The insulation and molybdenum disilicide (MoSi_2) heating elements are installed in the rectangular housing. The heating elements are vertically hanging (see 'view inside' figure) and can be replaced easily. At higher temperatures and in the presence of oxygen, MoSi_2 develops an oxide (SiO_2) layer, which protects the heating elements against further thermal or chemical corrosion.

Standard features

- 1800°C maximum operating temperature
- Programmable 3216P1 controller
- 3-zone models fitted with 1 x programmable 3216P1 and 2 x 3216CC end zone controllers, with retransmission of setpoint
- Over-temperature protection
- Accepts work tubes with outer diameters up to 100 mm for use with modified atmosphere
- Accepts work tubes with outer diameters up to 200 mm for use in air
- Heated lengths of 100, 250, 300 or 600 mm
- High grade thermocouple type B
- Low thermal mass ceramic fibre insulation
- High quality MoSi_2 heating elements in a vertical, hanging position
- Rectangular housing with holes for convection cooling
- Available with 1–3 heating zones
- Furnace comes with separate control box with 3 m cable, plug and socket



Control module with optional CC-T1 touchscreen programmer

HTRH 18/40/100 with optional CC-T1 controller

Options (specify these at time of order)

- A range of sophisticated digital controllers, multi-segment programmers and data loggers is available. These can be fitted with RS232, RS485 or Ethernet communications (see pages 106–111). Please note that special controllers may be needed for this model
- A range of additional work tubes is available in a variety of materials (see page 113)
- Insulation plugs & radiation shields are strongly recommended for high temperature vertical tube furnaces to prevent heat loss & improve uniformity (see page 117)
- Modified atmosphere and vacuum assemblies are available (see page 117)
- Vacuum packages with a choice of rotary vane pump or turbomolecular pump are available (page 118)
- Oxygen sensor for inert gas packages

View inside

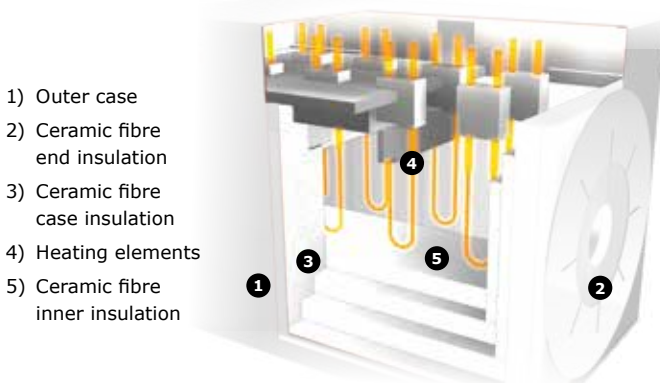

- 1) Outer case
- 2) Ceramic fibre end insulation
- 3) Ceramic fibre case insulation
- 4) Heating elements
- 5) Ceramic fibre inner insulation

HTRH-3 furnace with three heating zones

Better temperature uniformity can be achieved by dividing the heated length into 3-zones.

Each zone is equipped with a dedicated thermocouple and controller, which is especially useful to preheat gases required for reactions inside the system. The HTRH tube furnaces do not include an integral work tube. The work tube must be selected as an additional item. The work tube length is dependent on the application and will vary if used with or without modified atmosphere or vacuum.



HTRH – High Temperature Horizontal Tube Furnaces



Horizontal High Temperature Tube Furnace HTRH 18/70/600 with optional 3508P1 programmer and optional high vacuum capable inert gas package (high vacuum capable up to 1450 °C and up to 1800 °C under normal pressure. Rotary vane pumps and turbo pumps optional available (see page 118).

Technical data

CGN	Max. temperature [°C]	Dimensions: Max. outer Ø accessory tube [mm]	Dimensions: Heated length [mm]	Recommended tube length		Dimensions: External H x W x D [mm]	Furnace weight [kg]	Dimensions: Control module H x W x D* [mm]	Control module weight [kg]	Uniform length ± 5 °C [mm]	Max. power [W]
				for use in air [mm]	for use with modified atmosphere [mm]						
Model											

Single Zone High Temperature Horizontal Tube Furnaces HTRH

HTRH __/40/100	1600	40	100	380	915	510 x 390 x 420	45	480 x 560 x 500	50	50	2200
HTRH __/40/250	1600, 1700, 1800	40	250	530	1065	510 x 540 x 420	45	480 x 560 x 500	50	125	3600
HTRH __/40/500	1600, 1700, 1800	40	500	780	1275	510 x 790 x 420	60	850 x 560 x 500	90	250	8000
HTRH __/70/150	1600, 1700	70	150	440	975	620 x 450 x 520	65	480 x 560 x 500	60	75	4500
HTRH __/70/300	1600, 1700, 1800	70	300	580	1115	620 x 590 x 520	65	850 x 560 x 500	60	150	6400
HTRH __/70/600	1600, 1700, 1800	70	600	880	1415	620 x 890 x 520	90	850 x 560 x 500	90	300	8000
HTRH __/100/150	1600	100	150	440	975	620 x 450 x 520	75	480 x 560 x 500	60	75	4800
HTRH __/100/300	1600, 1700, 1800	100	300	580	1115	620 x 590 x 520	90	850 x 560 x 500	90	150	7500
HTRH __/100/600	1600, 1700, 1800	100	600	880	1415	620 x 890 x 520	120	850 x 560 x 500	90	300	10900
HTRH __/150/600	1600, 1700, 1800	150	600	880	Not available	670 x 890 x 570	140	850 x 560 x 500	90		12000
HTRH __/200/600	1600, 1700, 1800	200	600	880	Not available	720 x 890 x 620	180	850 x 560 x 500	90		12000

3-Zone High Temperature Horizontal Tube Furnaces HTRH

HTRH-3 __/70/600	1600, 1700, 1800	70	600	880	1415	620 x 890 x 520	120	850 x 560 x 500	180	350	8000
HTRH-3 __/100/600	1600, 1700, 1800	100	600	880	1415	620 x 890 x 520	120	850 x 560 x 500	180	350	10900
HTRH-3 __/100/900	1600, 1700, 1800	100	900	1180	1715	680 x 1190 x 650	250	1100 x 1200 x 700	230		20000
HTRH-3 __/150/600	1600, 1700, 1800	150	600	880	Not available	670 x 890 x 570	180	850 x 560 x 500	180		12000
HTRH-3 __/150/900	1600, 1700, 1800	150	900	1180	Not available	680 x 1190 x 650	250	1100 x 1200 x 700	230		20000

i Please note:

- Heat up rate when using an optional ceramic work tube must be limited to 5°C/min
- The power supply is based on 200–240 V for 1 phase and 380–415 V for 3 phase power
- Minimum uniform length in horizontal furnace with insulation plugs fitted at 100°C below max. temperature

- Maximum continuous operating temperature is 100°C below maximum temperature
- * Further to the depth of the control module 150 mm for the power plugs and other plugs needs to be added

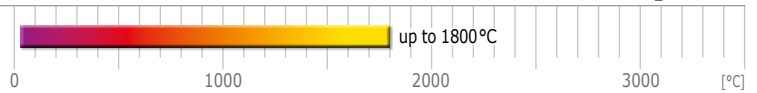

HTRV – High Temperature Vertical Tube Furnaces

The HTRV high temperature tube furnaces are designed for vertical orientation and operation up to 1800°C.

The high grade insulation material consisting of fibre plates provide low energy consumption and high heating rates due to their low thermal conductivity. The insulation and the molybdenum disilicide (MoSi_2) heating elements are installed in a rectangular housing. The heating elements hang vertically and can be easily replaced. At higher temperatures and in the presence of oxygen, MoSi_2 develops an oxide layer which protects the heating elements against further thermal or chemical corrosion.

With its wide range of accessories, the comprehensive HTRV range provides complete system solutions for ambitious thermal treatment at high temperatures.

Furnaces are supplied without a stand, allowing customers to build them into their own equipment. Optional 'L' stands are available allowing the furnaces to be self supporting.



HTRV 18/70/250 with optional CC-T1 controller, optional 'L' stand, optional voltage/current display and optional high vacuum/inert gas package (high vacuum possible up to 1450°C). Rotary vane and turbomolecular pumps available as options.

Standard features

- 1800°C maximum operating temperature
- Programmable 3216P1 controller
- Over-temperature protection
- Optimized for vertical usage
- Accepts work tubes with outer diameters up to 100 mm for use with modified atmosphere
- Accepts work tubes with outer diameters up to 200 mm for use in air
- Heated lengths of 100, 250 or 500 mm
- High grade type B thermocouple
- Low thermal mass ceramic fibre insulation
- Vertically hanging high quality MoSi_2 elements
- Rectangular housing with holes for convection cooling
- Furnace comes with separate control box with 3 m cable, plug and socket

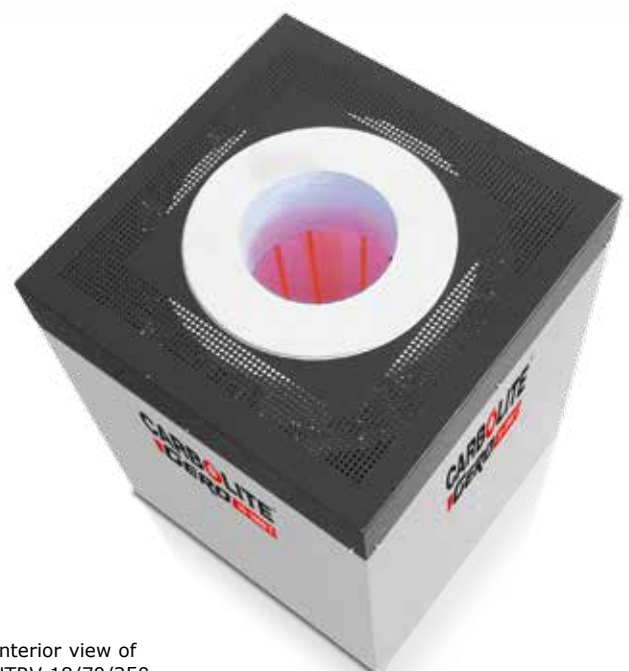

Interior view of HTRV 18/70/250 at high temperature

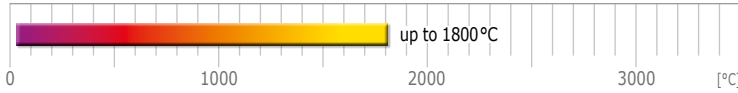

HTRV – High Temperature Vertical Tube Furnaces

Options (specify these at time of order)

- A range of sophisticated digital controllers, multi-segment programmers and data loggers is available. These can be fitted with RS232, RS485 or Ethernet communications (see pages 106 – 111). Please note that special controllers may be needed for this model
- A range of additional work tubes is available in a variety of materials (see page 113)
- Insulation plugs & radiation shields are strongly recommended for high temperature vertical tube furnaces to prevent heat loss & improve uniformity (see page 117)
- Modified atmosphere and vacuum packages are available (see page 117)
- Vacuum packages with a choice of rotary vane pump or turbomolecular pump are available (page 118)
- 'L' stand for convenient usage
- Oxygen sensor for inert gas packages



HTRV 17/150/250 with optional L-Stand, current / voltage display and recommended fibre insulation plugs

Technical data

CGN	Max. temperature [°C]	Dimensions: Max. outer Ø accessory tube [mm]	Dimensions: Heated length [mm]	Recommended tube length		Dimensions: External H x W x D [mm]	Furnace weight [kg]	Dimensions: Control module H x W x D* [mm]	Control module weight [kg]	Uniform length ± 5°C [mm]	Max. power [W]
				for use in air [mm]	for use with modified atmosphere [mm]						
Model											

High Temperature Vertical Tube Furnaces HTRV

HTRV __/40/100	1600, 1700	40	100	355	890	365 x 455 x 455	30	480 x 560 x 500	50	50	2000
HTRV __/40/250	1600, 1700, 1800	40	250	505	1040	515 x 455 x 455	40	480 x 560 x 500	50	125	3000
HTRV __/40/500	1600, 1700	40	500	755	1290	765 x 455 x 455	65	850 x 560 x 500	60	250	6000
HTRV __/70/100	1600, 1700	70	100	355	890	365 x 455 x 455	30	480 x 560 x 500	50	50	3000
HTRV __/70/250	1600, 1700, 1800	70	250	505	1040	515 x 455 x 455	40	850 x 560 x 500	60	125	4800
HTRV __/70/500	1600, 1700, 1800	70	500	755	1290	765 x 455 x 455	65	850 x 560 x 500	90	250	8000
HTRV __/100/250	1600, 1700, 1800	100	250	505	1040	515 x 455 x 455	45	850 x 560 x 500	60	125	7000
HTRV __/100/500	1600, 1700, 1800	100	500	755	1290	765 x 455 x 455	70	850 x 560 x 500	90	250	10400
HTRV __/150/250	1600, 1700, 1800	150	250	505	Not available	515 x 580 x 580	55	850 x 560 x 500	90		8000
HTRV __/150/500	1600, 1700, 1800	150	500	755	Not available	765 x 580 x 580	80	850 x 560 x 500	90		12000
HTRV __/200/250	1600, 1700, 1800	200	250	505	Not available	515 x 580 x 580	70	850 x 560 x 500	90		10000
HTRV __/200/500	1600, 1700, 1800	200	500	755	Not available	365 x 580 x 580	95	850 x 560 x 500	90		14000

i Please note:

- Heat up rate when using an optional ceramic work tube must be limited to 5°C/min
- The power supply is based on 200–240 V for 1 phase and 380–415 V for 3 phase power
- Minimum uniform length in horizontal furnace with insulation plugs fitted at 100°C below max. temperature

- Maximum continuous operating temperature is 100°C below maximum temperature
- * Further to the depth of the control module 150 mm for the power plugs and other plugs needs to be added

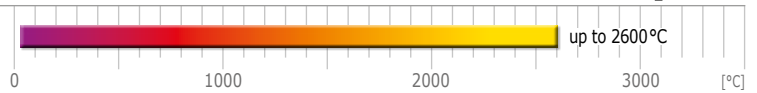

HTRH-GR – Graphite Tube Furnace up to 2600 °C

With the adjustable stand option, this range of Carbolite Gero graphite tube furnaces up to 2600 °C can be used at various angles, ranging from horizontal to vertical.

Custom designed manually controlled horizontal graphite heating and insulated tube furnace up to 2200 °C, with integral compact frame including the gas and water supply, and separate temperature controller cabinet

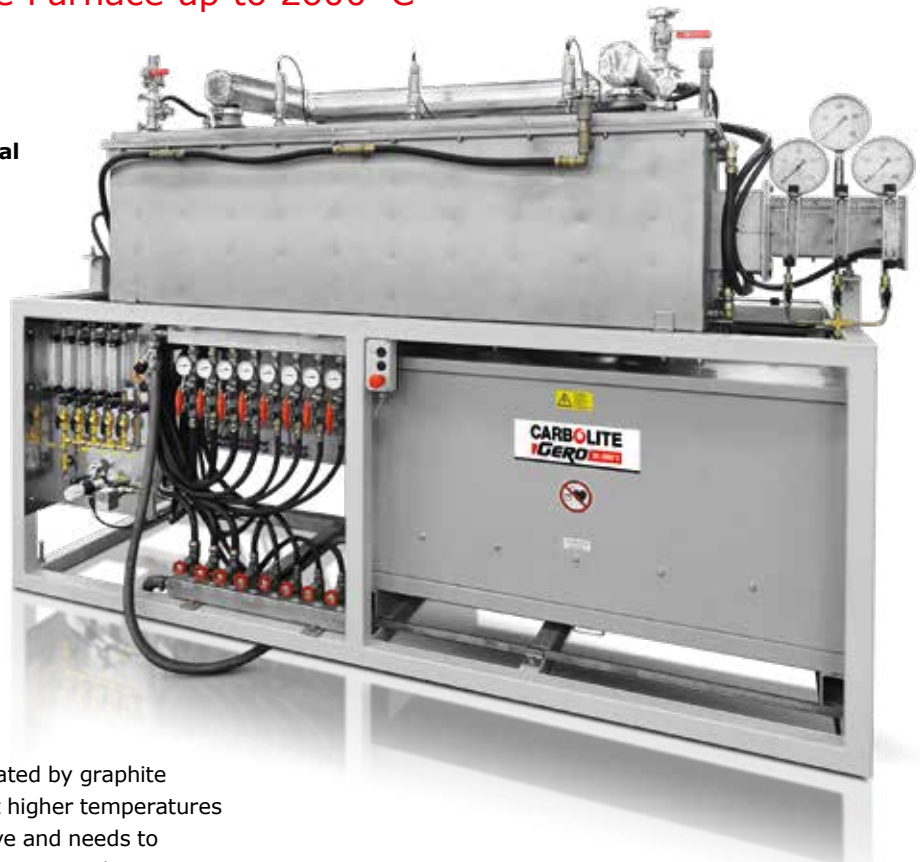

This range of cold wall tube furnaces is heated by graphite elements and insulated by graphite felt. At higher temperatures above 400 to 600 °C graphite is air sensitive and needs to be kept under either an inert gas or vacuum atmosphere. To maintain an oxygen free environment, the tube furnace is contained within in a water-cooled vacuum tight vessel sealed with rubber O-rings, which needs to be evacuated and purged with inert gas prior to heating.

The thermal conductivity of graphite felt insulation is very low making it an excellent material for furnace insulation. The thickness and quality of the insulation materials are specifically chosen depending on the maximum operating temperature of the furnace.

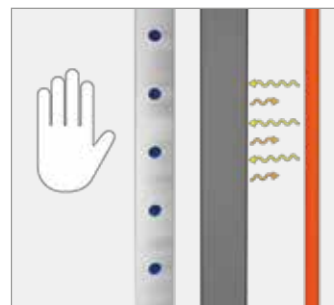

Insulation principle of the Graphite Tube Furnace; showing the graphite heater (red), the graphite felt insulation (dark grey) within the water cooled vessel

Standard features

- 2200, 2400 or 2600 °C maximum operating temperature
- Graphite heating and insulation
- Heated length of 260 mm
- Semi-automatic control with Siemens KP 300 panel
- Eurotherm 3508P1 programmer
- Pyrometer for temperature measurement
- Automatic gas valves with manual flowmeter for one inert gas
- Single stage rotary vane pump
- Water cooled vessel (cooling water provided by customer)
- Over-temperature protection
- Leakage rate (clean, cold, dry and empty) <math>< 5 \times 10^{-3}</math> mbar l/s
- Closed flanges during heat treatment mandatory

Options (specify these at time of order)

- Full automated control by Siemens PLC S7-300
- Control panel TP1900 or WinCC for PLC
- Further inert gas controls (manual or automated)
- Double stage rotary and turbo pumps
- Adjustable angle stand
- Sliding thermocouple for accurate temperature control under 1500 °C
- Reference pyrometer (only with PLC)
- Water cooling chiller (if cooling water is not available)
- Special flanges with inert gas counter flow for open operation during heat treatment

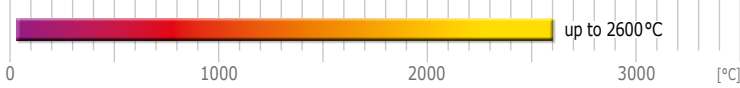

HTRH-GR – Graphite Tube Furnace up to 2600 °C

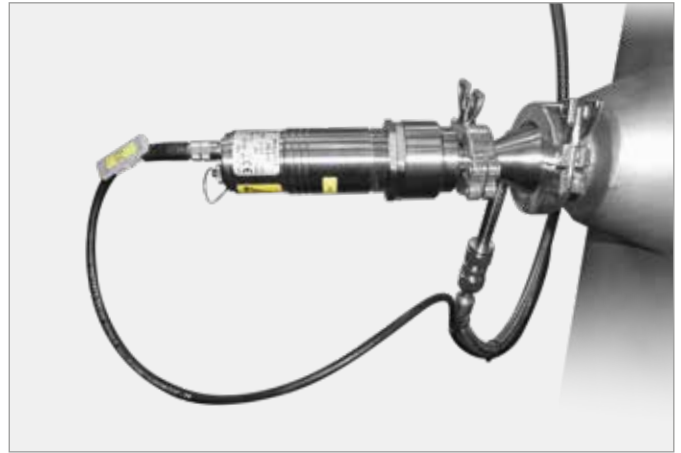

At temperatures higher than 1800 °C, temperature measurement requires a pyrometer

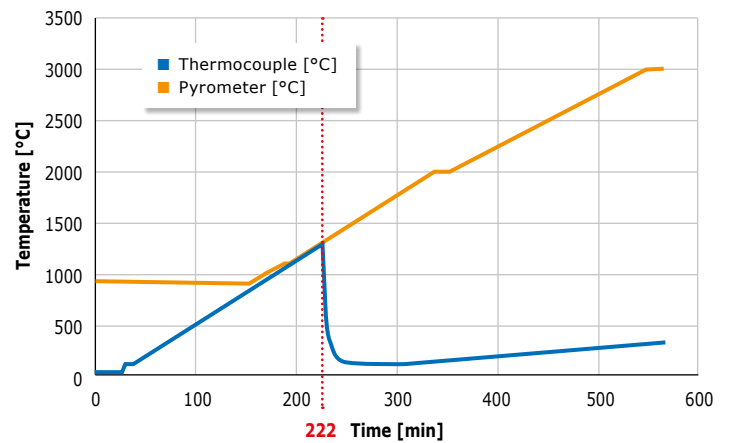
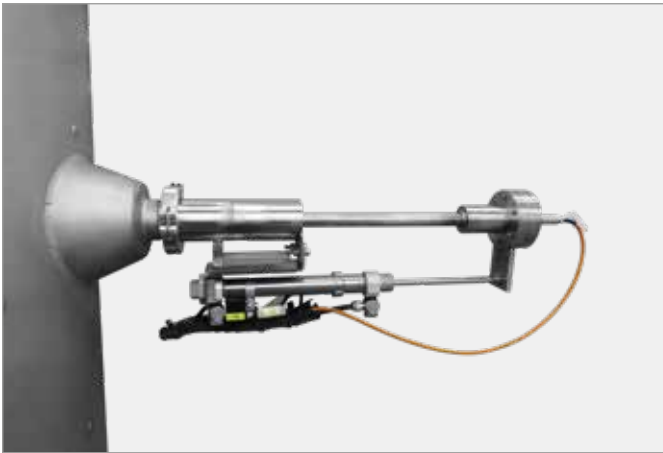

For accurate temperature measurement up to 1500 °C an optional sliding thermocouple type S is recommended (left); example temperature measurement of pyrometer and sliding thermocouple (right). Here after 222 minutes the thermocouples slides out and the pyrometer takes over the temperature control.

Technical data

CGN	Max. temp. under Argon [°C]	Max. temp. under vacuum [°C]	Cooling time from 2000 °C [h]	Inner tube diameter [mm]	Heated length [mm]	Outer dimensions tube furnace without stand Ø* x W [mm]	Outer dimensions tube furnace with stand H x W x D [mm]	Outer dimensions control module H x W x D [mm]	Furnace weight in total [kg]	Required Argon gas flow [l/h]	Required cooling water flow [l/min]	Max. power [W]
HTRH-GR 22/260	2200	2200	5	50	260	400 x 900	1800 x 900 x 1000	1500 x 1500 x 1000	600	50-500	25	23000
HTRH-GR 24/260	2400	2200	5	50	260	400 x 900	1800 x 900 x 1000	1500 x 1500 x 1000	700	50-500	35	32000
HTRH-GR 26/260	2600	2200	5	50	260	400 x 900	1800 x 900 x 1000	1500 x 1500 x 1000	800	50-500	50	42000

i Please note:

- Heat up rate to 2000 °C approx. 10°C/min, above 2000 °C lower
- Power supply by 3 phase power with 380-415 Volts with neutral and earth required
- *Further to the diameter of the tube furnace the current feed in connections have an outer diameter of 800 mm

- Inert gas and cooling water supply mandatory
- Maximum continuous operating temperature is 100 °C below maximum temperature
- Above 2000 °C the wear down of the heating elements grows with raising temperature exponentially

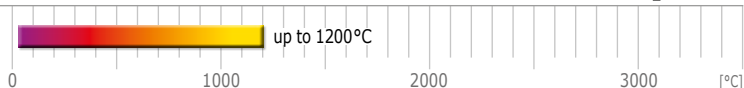

EST, EZS, EVT, EVZ – Compact Split Tube Furnaces

These compact universal split tube furnaces use free radiating wire elements embedded within the insulation of the furnace body. The benefit of this design is its flexibility; with the use of tube adapters the same furnace can be used with a variety of tube diameters.

The single zone EST and EVT and 3-zone EZS and EVZ split tube furnaces comprise a furnace body which is hinged and split into two halves along its length. This makes exchange of work tubes easier and also enables the furnace to be used with reactors or work tubes where end flanges would make insertion into a non-split furnace difficult.

The 3-zone EZS and EVZ furnaces provide excellent uniformity resulting from division of the heated length into 3-zones with its own controller and thermocouple. This range of tube furnaces does not include an integral work tube which must be selected as an additional item. The work tube length is dependent on the application, for example, for use with modified atmosphere or vacuum; this information can be found on pages 112 – 113.

The use of a separate work tube has the advantage of protecting the heating elements from damage or contamination.



EST 12/300 with CC-T1 temperature programmer

Standard features

- 1200 °C maximum operating temperature
- Carbolite Gero 301 digital PID controller with single ramp to setpoint, digital display and process timer
- Heated lengths, single zone 150, 300, 450 or 600 mm (EST, EVT)
- Heated lengths, 3-zone 450 or 600 mm (EZS, EVZ)
- Accepts work tubes with outer diameters up to 60 mm
- Wire elements in high quality vacuum formed insulation ensure fast heat up, excellent temperature uniformity and short cool down times
- Furnace splits into two halves and accommodates tubes or samples fixed into a test rig
- Models: EST, EZS: Horizontal split configuration
- Models: EVT, EVZ: Vertical split configuration
- Models: EST, EVT: Single zone
- Models: EZS, EVZ: 3-zone
- Outer mesh guard ensures operator safety

Options (specify these at time of order)

- A range of sophisticated digital controllers, multi-segment programmers and data loggers is available. These can be fitted with RS232, RS485 or Ethernet communications (see pages 106 – 111)
- Over-temperature protection (recommended to protect valuable contents & for unattended operation)
- A range of additional work tubes (pages 112 – 113), end seals (page 116) and work tube packages (pages 114 – 115) is available for use with modified atmosphere and/or vacuum
- Vacuum packages with a choice of rotary vane pump or turbomolecular pump are available (page 118)
- Wide choice of tube diameters and materials is available. See pages 112 – 113 for tube materials and dimensions
- Insulation plugs and radiation shields to prevent heat loss and improve uniformity

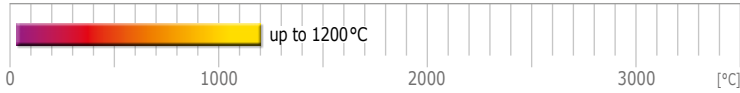

EST, EZS, EVT, EVZ – Compact Split Tube Furnaces



Technical data

Model	Max. temp. [°C]	Heat up time [mins]	Dimensions: Max. outer ø accessory tube [mm]	Dimensions: Heated length [mm]	Recommended tube length		Dimensions: External H x W x D [mm]	Uniform length ± 5 °C [mm]	Max. power [W]	Thermocouple Type	Weight [kg]
					for use in air [mm]	for use with modified atmosphere [mm]					

Single Zone Horizontal Compact Split Tube Furnaces EST

EST 12/150B	1200	46	60	150	300	600	560 x 370 x 390	80	750	N	16
EST 12/300B	1200	34	60	300	450	750	560 x 465 x 390	185	1480	N	18
EST 12/450B	1200	44	60	450	600	900	560 x 615 x 390	300	2000	N	20
EST 12/600B	1200	45	60	600	750	1050	560 x 765 x 390	460	2520	N	24

3-Zone Horizontal Compact Split Tube Furnaces EZS

EZS 12/450B	1200	55	60	450	600	900	560 x 615 x 390	335	2000	N	21
EZS 12/600B	1200	55	60	600	750	1050	560 x 765 x 390	470	2520	N	26

Single Zone Vertical Compact Split Tube Furnaces EVT

EVT 12/150B	1200	-	60	150		600	710 x 545 x 545	75	750	N	20
EVT 12/300B	1200	58	60	300		750	1040 x 545 x 545	180	1480	N	27
EVT 12/450B	1200	52	60	450		900	1040 x 545 x 545	250	2000	N	29
EVT 12/600B	1200	49	60	600		1050	1160 x 545 x 545	370	2520	N	33

3-Zone Vertical Compact Split Tube Furnaces EVZ

EVZ 12/450B	1200	58	60	450		900	1040 x 545 x 545	338	2000	N	31
EVZ 12/600B	1200	58	60	600		1050	1160 x 545 x 545	455	2520	N	36

i Please note:
 - Heat up rate when using an optional ceramic work tube must be limited to 5°C/min
 - Heat up time is measured to 100°C below maximum, using an empty work tube and insulation plugs

- Holding power is measured at continuous operating temperature
 - Maximum continuous operating temperature is 100°C below maximum temperature
 - Dimensions excluding control box (225 x 370 x 390 mm)

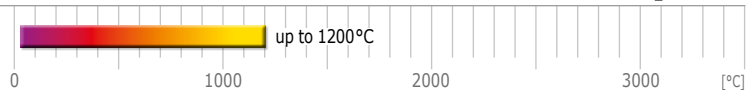

HST, HZS – Horizontal Split Tube Furnaces



HZS 12/900 with CC-T1 3-zone temperature programmer

The single zone HST and three zone HZS tube furnace range uses free radiating wire elements embedded within the insulation of the furnace body. The benefit of this design is its flexibility; with the use of tube adapters the same furnace can be used with a variety of tube diameters.

These furnaces comprise a furnace body which is hinged and split into two halves along its length. This makes exchange of work tubes easier and also enables the furnace to be used with reactors or work tubes where end flanges would make insertion into a non-split furnace difficult. This range of tube furnaces does not include an integral work tube and one must be selected as an additional item. The work tube length is dependent on the application, for example, for use with modified atmosphere or vacuum. This information can be found on pages 112–113.

The use of a separate work tube has the advantage of protecting the heating elements from damage or contamination.

The HZS offers excellent uniformity which results from division of the heated length into 3-zones each with its own controller and thermocouple.

Options (specify these at time of order)

- A range of sophisticated digital controllers, multi-segment programmers and data loggers is available. These can be fitted with RS232, RS485 or Ethernet communications (see pages 106–111)
- Over-temperature control; recommended for unattended operation and to protect a valuable load
- A range of additional work tubes (pages 112–113), end seals (page 116) and work tube packages (pages 114–115) is available for use with modified atmosphere and/or vacuum
- Vacuum packages with a choice of rotary vane pump or turbomolecular pump are available (page 118)
- Insulation plugs, gas tight end seals and vacuum connections available
- Wide choice of tube diameters and materials is available. See pages 112–113 for tube materials and dimensions
- Available with 'L' stand for vertical and horizontal use
- Control module on longer 6 metre conduit
- HZS: Three equal length zones
- HZS: If programmed cooling is required, programmable controllers capable of retransmission of setpoint can be supplied.

Standard features

- 1200°C maximum operating temperature
- Carbolite Gero 301 digital PID controller with single ramp to setpoint, digital display and process timer
- Accepts work tubes with outer diameters up to 110 mm
- Heated lengths, single zone 200, 300, 400, 450, 600 or 900 mm
- Heated lengths, 3-zone 600 or 900 mm
- Horizontal furnace with a separate control module on a 2 metre conduit
- Furnace splits into two halves to accommodate work tubes or samples fixed into a test rig
- Wire elements in high quality vacuum formed insulation ensure fast heat up, excellent temperature uniformity and short cool down times
- HZS: End zone control is via back to back thermocouples
- HZS: End zones of 150 mm at each end

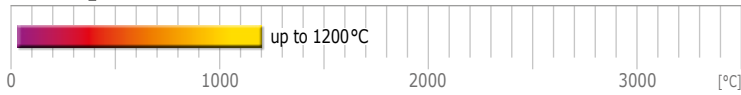

HST, HZS – Horizontal Split Tube Furnaces



HST 12/600 with work tube option

Technical data

CGH	Model	Max. temp. [°C]	Heat-up time [mins]	Dimensions: Max. outer Ø accessory tube [mm]	Dimensions: Heated length [mm]	Dimensions: Furnace body length [mm]	Recommended tube length		Dimensions: External Furnace H x W x D [mm]	Dimensions: Control module H x W x D [mm]	Uniform length ± 5°C [mm]	Max. power [W]	Holding power [W]	Thermo-couple type	Weight [kg]
							for use in air [mm]	for use with modified atmosphere [mm]							

Single Zone Horizontal Split Tube Furnaces HST

HST 12/200	1200	45	110	200	350	350	650	350 x 350 x 410	222 x 370 x 376	100	1000	800	N	26
HST 12/300	1200	45	110	300	450	450	750	350 x 450 x 410	222 x 370 x 376	150	1500	850	N	28
HST 12/400	1200	45	110	400	550	550	850	350 x 550 x 410	222 x 370 x 376	200	2000	900	N	32
HST 12/450	1200	56	110	450	600	600	900	360 x 600 x 445	222 x 370 x 376	220	2250	950	N	33
HST 12/600	1200	47	110	600	750	750	1050	350 x 750 x 410	222 x 370 x 376	300	3000	1100	N	38
HST 12/900	1200	45	110	900	1050	1050	1350	350 x 1050 x 410	222 x 370 x 376	450	4500	1450	N	60

3-Zone Horizontal Split Tube Furnaces HZS

HZS 12/600	1200	45	110	600	750	750	1050	350 x 750 x 410	225 x 570 x 380	500	3000	1000	N	40
HZS 12/900	1200	45	110	900	1050	1050	1350	350 x 1050 x 410	225 x 570 x 380	750	4500	1400	N	65

i Please note:

- Heat up rate when using an optional ceramic work tube must be limited to 5°C/min
- Holding power is measured at continuous operating temperature
- Heat up time is measured to 100°C below max, using an empty tube & insulation plugs

- Control box width increases to 570 mm for models with three phase power supply
- Uniform length measured with insulation plugs fitted
- Maximum continuous operating temperature is 100°C below maximum temperature

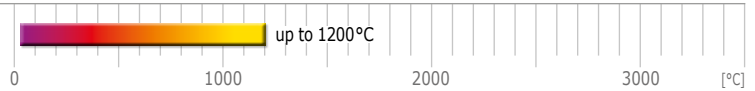

VST 12, TVS 12 – Vertical Split Tube Furnaces

The single zone VST 12 and three zone TVS 12 tube furnace range uses free radiating wire elements embedded within the insulation of the furnace body. The benefit of this design is its flexibility; with the use of tube adapters the same furnace can be used with a variety of tube diameters.

These furnaces comprise a furnace body which is hinged and split into two halves along its length. This makes exchange of work tubes easier and also enables the furnace to be used with reactors or work tubes where end flanges would make insertion into a non-split furnace difficult. This design is particularly suitable for incorporation into extension test and creep test apparatus.

This range of tube furnaces does not include an integral work tube and one must be selected as an additional item. The work tube length is dependent on the application e.g. for use with modified atmosphere or vacuum. This information can be found on pages 112–113. The use of a separate work tube has the advantage of protecting the heating elements from damage or contamination. The 'near-hinge' format is standard, an alternative option that can be specified at the time of purchase is the 'far-hinge' format, where the pivot of hinges is further from the centre line of the furnace to enable a wider opening action.



VST 12/600 with 3216P1 programmer option

Standard features

- 1200°C maximum operating temperature
- Carbolite Gero 301 digital PID controller with single ramp to setpoint, digital display and process timer
- Accepts work tubes with outer diameters up to 110 mm
- Heated lengths, single zone 200, 300, 400, 450, 600 or 900 mm (VST)
- Heated lengths, 3-zone 600 or 900 mm (TVS)
- Furnace splits into two halves and accommodates tubes or samples fixed into a test rig
- Wire elements in high quality vacuum formed insulation ensure fast heat up, excellent temperature uniformity and short cool down times
- Supplied in 'near-hinge' configuration complete with stand
- Vertical furnace with a separate control module on a 2 metre conduit
- End zone control is via back to back thermocouples (TVS only)
- End zones of 150 mm (TVS only)

Options (specify these at time of order)

- A range of sophisticated digital controllers, multi-segment programmers and data loggers is available. These can be fitted with RS232, RS485 or Ethernet communications (see pages 106–111)
- Over-temperature control; recommended for unattended operation and to protect a valuable load
- A range of additional work tubes (pages 112–113), end seals (page 116) and work tube packages (pages 114–115) is available for use with modified atmosphere and/or vacuum
- Vacuum packages with a choice of rotary vane pump or turbomolecular pump are available (page 118)
- Insulation plugs, gas tight end seals and vacuum connections available
- 'Far-hinge' configuration providing wider opening of furnace body
- Wide choice of tube diameters and materials is available. See pages 112–113 for tube materials and dimensions
- Control module on longer 6 metre conduit
- Three equal length zones (TVS)

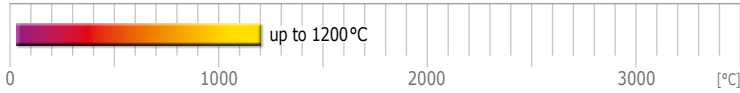

VST 12, TVS 12 – Vertical Split Tube Furnaces

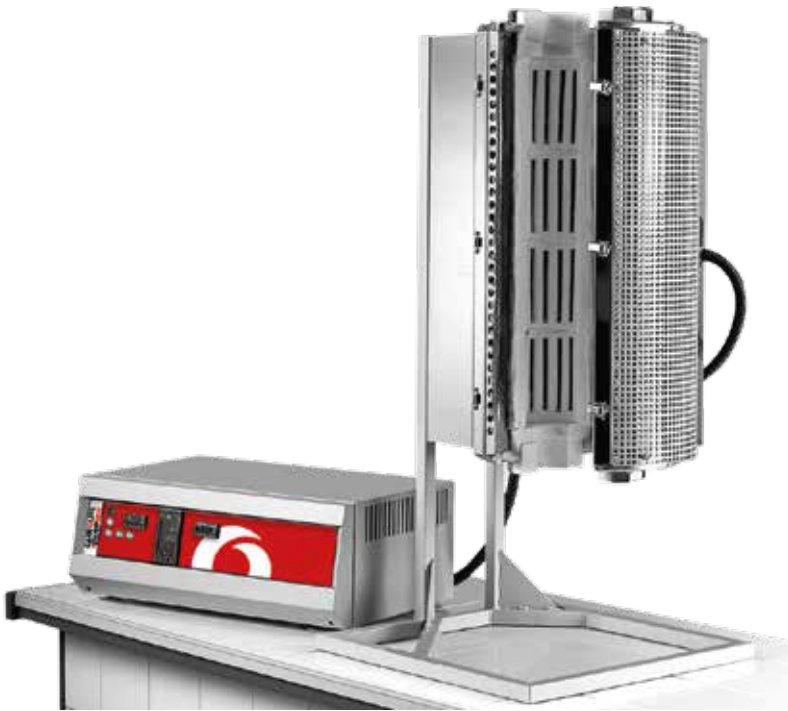

TVS 12/600
with 3508P1 programmer option

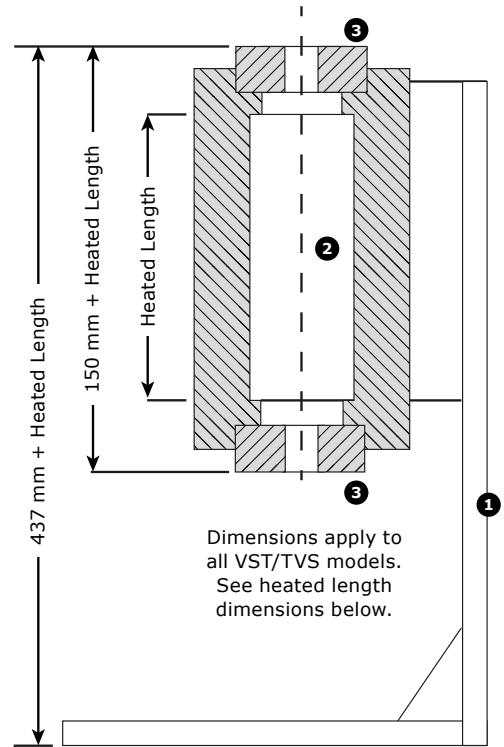

VST/TVS Tube Furnace
on Standard Support Stand

- 1) Vertical stand
- 2) Furnace heated zone
- 3) Removable work tube adapters

Technical data

Model	Max. temp. [°C]	Heat-up time [mins]	Dimensions: Max. outer Ø accessory tube [mm]	Dimensions: Heated length [mm]	Dimensions: Furnace body length [mm]	Recommended tube length		Dimensions: External Furnace (inc. stand) H x W x D [mm]	Dimensions: Control module H x W x D [mm]	Uni-form length ± 5°C [mm]	Max. power [W]	Hold-ing power [W]	Ther-mo-couple type	Weight [kg]
						for use in air [mm]	for use with modified atmosphere [mm]							

Single Zone Vertical Split Tube Furnaces VST

VST 12/200	1200	45	110	200	350	550	650	640 x 500 x 495	222 x 370 x 376	-	1000	800	N	24
VST 12/300	1200	45	110	300	450	650	750	740 x 500 x 495	222 x 370 x 376	-	1500	850	N	25
VST 12/400	1200	45	110	400	550	750	850	840 x 500 x 495	222 x 370 x 376	-	2000	900	N	26
VST 12/450	1200	53	110	450	600	800	900	890 x 500 x 500	222 x 370 x 376	215	2250	950	N	30
VST 12/600	1200	45	110	600	750	950	1050	1040 x 500 x 495	222 x 370 x 376	-	3000	1100	N	32
VST 12/900	1200	45	110	900	1050	1250	1350	1340 x 500 x 675	225 x 570 x 380	-	4500	1450	N	44

3-Zone Vertical Split Tube Furnaces TVS

TVS 12/600	1200	45	110	600	750	950	1050	1040 x 500 x 495	225 x 570 x 380	500	3000	1100	N	34
TVS 12/900	1200	45	110	900	1050	1250	1350	1340 x 500 x 675	225 x 570 x 380	750	4500	1450	N	44

i Please note:

- Heat up rate when using an optional ceramic work tube must be limited to 5°C/min
- Heat up time is measured to 100°C below max, using an empty tube & insulation plugs
- Uniform length measured with insulation plugs fitted

- Control box width increases to 570 mm for models with three phase power supply
- Maximum continuous operating temperature is 100°C below maximum temperature

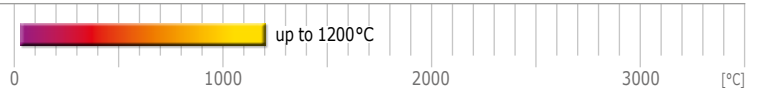

KST, KZS, KVT and KVZ – Large Split Tube Furnaces

The K range horizontal and vertical split tube furnaces have been designed for use with work tubes or reactor vessels up to 200 mm outer diameter.

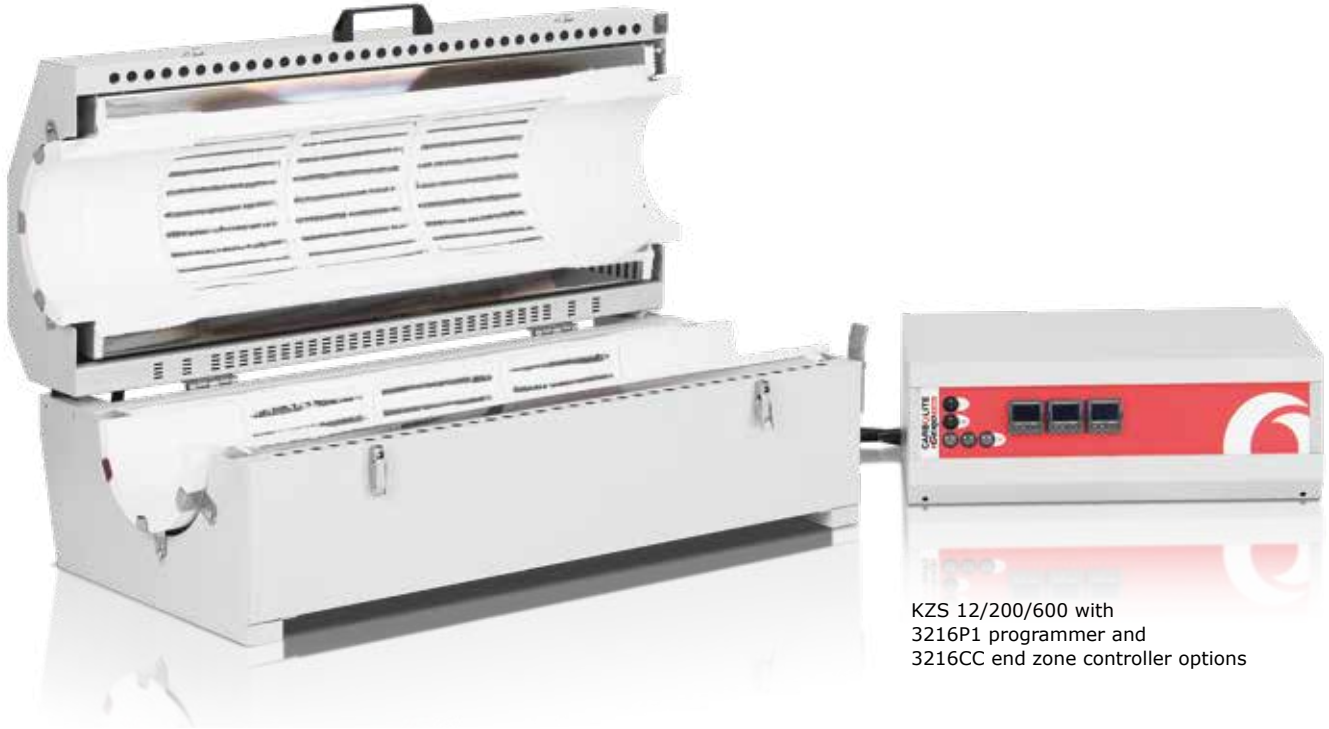

KZS 12/200/600 with
3216P1 programmer and
3216CC end zone controller options

The furnace body is hinged and split into two along its length and is held closed with over-centre clamps providing easy access to reactors or work tube. These furnaces can be used for many applications such as heating reactors in pilot plant or the manufacture of plastic parts in the automotive industry.

The large diameter of the K range furnaces is perfect for heat treatment of wafers and fuel cells.

Extended length work tubes of 200 mm diameter are possible in quartz and APM.

Standard features

- 1200°C maximum operating temperature
- Single zone models fitted with Carbolite Gero 301 PID controller with single ramp to setpoint and process timer
- 3-zone models fitted with 1 x Carbolite Gero 301 PID controller and 2 x 2132 slave end zone controllers
- To suit work tubes or work pieces up to an outside diameter of 200 mm
- Heated length of 600 or 1200 mm
- Furnace splits into two halves and accommodates tubes or samples fixed into a test rig
- Wire elements in high quality vacuum formed insulation ensure fast heat up, excellent temperature uniformity and short cool down times

Options (specify these at time of order)

- Over-temperature control; recommended for unattended operation and to protect a valuable load
- 300 mm diameter on request
- Horizontal or vertical configurations

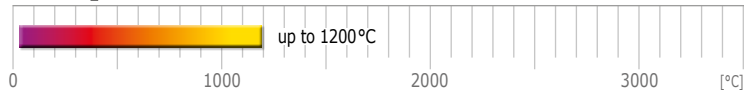

KST, KZS, KVT and KVZ – Large Split Tube Furnaces



KVZ 12/200/600 with 3216P1 programmer and 2 x 3216CC end zone controller options



KVZ 12/200/1200 with 3216P1 programmer and 2 x 3216CC end zone controller options

Technical data

Model	Max. temp. [°C]	Max. continuous operating temperature [°C]	Dimensions: Max. outer Ø accessory tube [mm]	Dimensions: Heated length [mm]	Dimensions: External furnace H x W x D [mm]	Recommended tube length		Dimensions: control box H x W x D [mm]	Max. power [W]
						for use in air [mm]	for use with modified atmosphere [mm]		
Single Zone Large Horizontal Split Tube Furnaces KST									
KST 12/200/600	1200	1100	200	600	450 x 1015 x 690 (closed) 740 x 1015 x 690 (open)	1100	1300	225 x 570 x 380	8000
3-Zone Large Horizontal Split Tube Furnaces KZS									
KZS 12/200/600	1200	1100	200	Left zone = 200 Centre zone = 200 Right zone = 200	450 x 1015 x 690 (closed) 740 x 1015 x 690 (open)	1100	1300	225 x 570 x 380	8000
KZS 12/200/1200	1200	1100	200	Left zone = 400 Centre zone = 400 Right zone = 400	450 x 1620 x 690 (closed) 750 x 1620 x 690 (open)	1700	1900	225 x 570 x 380	14700
Single Zone Large Vertical Split Tube Furnaces KVT									
KVT 12/200/600	1200	1100	200	600	1690 x 800 x 940	1100	1300	225 x 570 x 380	8000
3-Zone Large Vertical Split Tube Furnaces KVZ									
KVZ 12/200/600	1200	1100	200	Top zone = 200 Centre zone = 200 Bottom zone = 200	1690 x 800 x 940	1100	1300	225 x 570 x 380	8000
KVZ 12/200/1200	1200	1100	200	Top zone = 400 Centre zone = 400 Bottom zone = 400	2300 x 800 x 940	1700	1900	225 x 570 x 380	18000

i Please note:
- Heat up rate when using an optional ceramic work tube must be limited to 5°C/min

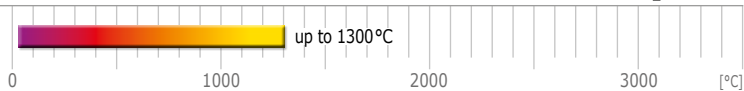

FST, FZS – Horizontal and Vertical Split Tube Furnaces

The FST, single zone, and FZS, 3-zone, split tube furnaces can be used either vertically or horizontally and have a maximum operating temperature of 1300°C.

The split heating module allows either easy positioning of the work tube or positioning around reactors which have fixed end flanges. The split design may also allow faster cooling of the sample. Cooling channels are engineered into the housing to aid with convection cooling of the outer case. A handle is attached to the upper half of the split tube furnace with two quick-release clamps to safely unlock and lock the furnace. The two furnace halves are ceramic fibre modules with high quality APM wire heating elements mounted in the insulation, held in position by a ceramic holding ridge. A safety switch protects the operator by switching off the heating elements once the furnace is opened.



FST 13/70/500
with optional
CC-T1 controller



Control module with
optional CC-T1 touchscreen
programmer

Options (specify these at time of order)

- A range of sophisticated digital controllers, multi-segment programmers and data loggers is available. These can be fitted with RS232, RS485 or Ethernet communications (see pages 106–111).
- Over-temperature protection (recommended to protect valuable contents & for unattended operation)
- Wide choice of tube diameters and materials is available. See pages 112–113 for tube materials and dimensions
- For split tube furnaces, robustly shaped ceramic half tubes are available to protect the heating elements and for sample holding
- 'L' stand for vertical and/or horizontal use
- Insulation plugs & radiation shields to prevent heat loss & improve uniformity (see page 117)
- Modified atmosphere and vacuum packages are available (see page 117)
- Vacuum packages with a choice of rotary vane pump or turbomolecular pump are available (page 118)
- Larger tube diameters
- Longer heated lengths
- Automated opening mechanism
- Flanges for inert gas counter flow
- Oxygen sensor for inert gas packages

Standard features

- 1300°C maximum operating temperature
- Carbolite Gero 3216CC controller, with single ramp to setpoint & process timer
- 3-zone models fitted with 1 x 3216CC and 2 x 3216CC end zone controllers, with retransmission of setpoint
- Accepts work tubes with outer diameter up to 150 mm
- Single-zone heated lengths of 200, 500 or 1000 mm
- 3-zone heated lengths of 500 or 1000 mm
- Split design allows work tubes or reactors with fixed flanges to be accommodate
- For horizontal or vertical use
- Exceptionally long life time and temperature stability
- High grade type S thermocouple
- Low thermal mass ceramic fibre insulation
- High quality 5 mm APM wire heating elements
- Supplied with separate control box with 3 m cable, plug and socket



Custom designed 3-zone FZS 13/100/4500 with 4500 mm heated length, automated opening and APM work tube

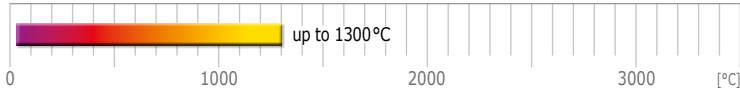

FST, FZS – Horizontal and Vertical Split Tube Furnaces

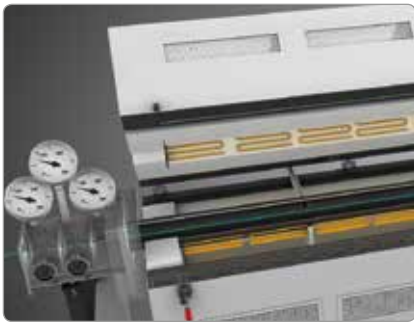

Interior view of custom designed FZS with flanges for inert gas counter flow for open operation during inert gas heat treatment



Custom designed 6-zone FZS 13/100/3000 with 3000 mm heated length and counter flow flanges. For simultaneous heat treatment of four carbon fibres under inert gas atmosphere. Supplied with separate control cabinet.

Technical data

CGN Model	Max. temp. [°C]	Dimensions: Max. outer Ø accessory tube [mm]	Dimensions: Heated length [mm]	Recommended tube length		Dimensions: External furnace H x W x D [mm]	Furnace weight [kg]	Dimensions: Control module H x W x D* [mm]	Control module weight [kg]	Uniform length ± 5°C [mm]	Max. power [W]
				for use in air [mm]	for use with modified atmosphere [mm]						

Single Zone Horizontal and Vertical Split Tube Furnaces FST (may need further equipment)

FST 13/40/200	1300	40	200	450	985	530 x 460 x 560	35	480 x 560 x 500	50	100	1500
FST 13/70/500	1300	70	500	670	1205	530 x 680 x 560	50	480 x 560 x 500	50	250	3000
FST 13/100/500	1300	100	500	670	1205	530 x 680 x 560	75	850 x 560 x 500	60	250	4000
FST 13/100/1000	1300	100	1000	1190	1725	530 x 1200 x 560	80	850 x 560 x 500	90	500	10400
FST 13/150/1000	1300	150	1000	1190	1725	590 x 1200 x 560	100	850 x 560 x 500	90	500	12000

3-Zone Horizontal and Vertical Split Tube Furnaces FZS (may need further equipment)

FZS 13/70/500	1300	70	500	670	1205	530 x 680 x 560	50	480 x 560 x 500	50	350	3000
FZS 13/100/500	1300	100	500	670	1205	530 x 680 x 560	75	850 x 560 x 500	60	300	4000
FZS 13/100/1000	1300	100	1000	1190	1725	530 x 1200 x 560	80	1100 x 1200 x 700	90	800	10400
FZS 13/150/1000	1300	150	1000	1190	1725	590 x 1200 x 560	100	1100 x 1200 x 700	90	600	12000
FZS 13/200/1000	1300	200	1000	1190**	1725**	690 x 1200 x 620	150	1100 x 1200 x 700	120		16000

3-Zone Horizontal Split Tube Furnaces FZS (may need further equipment)

FZS 13/100/1500	1300	100	1500	1690	2225	530 x 1700 x 560	120	1100 x 1200 x 700	120		14000
FZS 13/100/4500	1300	100	4500	on request	on request	2200 x 4700 x 1100	800	inside frame	-		45000
FZS 13/150/1500	1300	150	1500	1690**	2225**	590 x 1700 x 560	150	1100 x 1200 x 700	120		18000
FZS 13/150/4500	1300	150	4500	on request	on request	2200 x 4700 x 1200	950	inside frame	-		60000
FZS 13/200/1500	1300	200	1500	1690**	2225**	690 x 1700 x 620	200	1100 x 1200 x 700	160		22000

i Please note:

- Heat up rate when using an optional ceramic work tube must be limited to 5°C/min
- The power supply is based on 200–240 V for 1 phase and 380–415 V for 3 phase power
- Minimum uniform length in horizontal furnace with insulation plugs fitted at 100°C below max. temperature

- * Further to the depth of the control module 150 mm for the power plugs and other plugs needs to be added
- ** (APM or quartz)

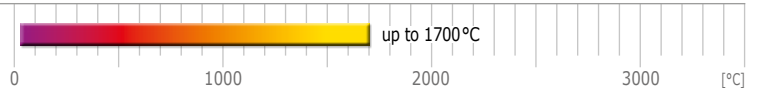

HTRV-A – High Temperature Vertical Split Tube Furnaces

The HTRV-A split tube furnaces have a maximum operating temperature of 1700°C.

The split heating module allows either easy positioning of the work tube or positioning around reactors which have fixed end flanges. The split design may also allow faster cooling of samples. The control thermocouple is fitted in the centre of the heating zone. Cooling channels are engineered into the housing to aid with convection cooling of the outer case. The two furnace chamber halves consist of high grade insulation plates with vertically hanging MoSi_2 heating elements. A safety switch protects the operator by switching off the heating elements once the furnace is opened.

Furnaces are supplied without a stand, allowing customers to build them into their own equipment. Optional 'L' stands are available allowing the furnaces to be self supporting.

Standard features

- 1600 and 1700°C maximum operating temperatures
- Programmable 3216P1 controller
- Over-temperature protection
- Designed for vertical use
- Accepts work tubes with outer diameters up to 100 mm for use with modified atmosphere
- Heated lengths of 120, 250, 500 or 700 mm
- High grade type B thermocouple
- Low thermal mass ceramic fibre insulation
- Vertically hanging high quality MoSi_2 heating elements
- Rectangular housing with holes for convection cooling
- Supplied with separate control box and 3 m cable, plug and socket



HTRV-A 17/100/700 with optional stand

View inside the HTRV-A

- 1) Outer case
- 2) Ceramic fibre end insulation
- 3) Ceramic fibre case insulation
- 4) Heating elements
- 5) Ceramic fibre inner insulation

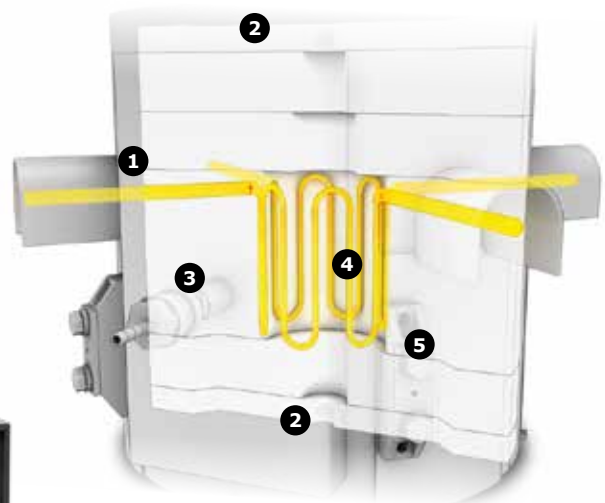

HTRV-A 17/70/250
with optional basic inert gas bundle



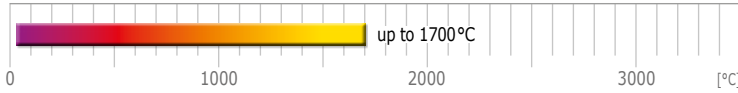

HTRV-A – High Temperature Vertical Split Tube Furnaces

Options (specify these at time of order)

- A range of sophisticated digital controllers, multi-segment programmers and data loggers is available. These can be fitted with RS232, RS485 or Ethernet communications (see pages 106 – 111). Please note that special controllers may be needed for this model
- A range of additional work tubes is available in a variety of materials (see page 113)
- Insulation plugs & radiation shields are strongly recommended for high temperature vertical tube furnaces to prevent heat loss & improve uniformity (see page 117)
- Modified atmosphere and vacuum packages are available (see page 117)
- Vacuum packages with a choice of rotary vane pump or turbomolecular pump are available (page 118)
- Longer heated lengths
- 'L' stand for convenient usage
- Oxygen sensor for inert gas packages

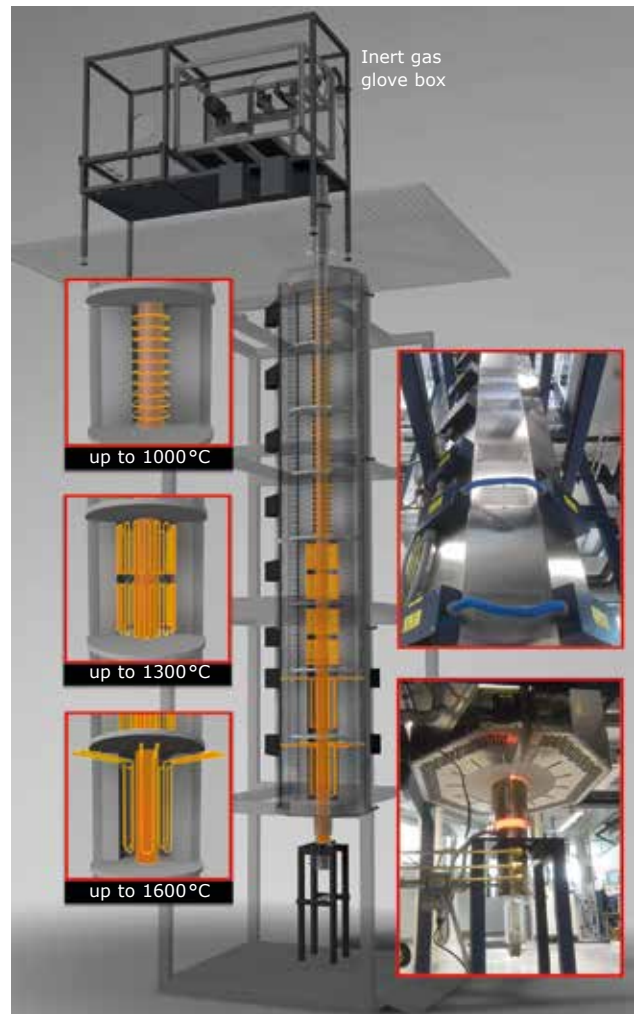

Custom designed 8-zone vertical split tube furnace, model HTRV-A 16/100/4000, with 4000 mm heated length. For debinding and sintering of fibres under inert gas atmosphere. The fibres are introduced into the furnace from an inert gas glove box.

Technical data

CGN	Max. temperature [°C]	Dimensions: Max. outer Ø accessory tube [mm]	Dimensions: Heated length [mm]	Recommended tube length		Dimensions: External H x W x D [mm]	Furnace weight [kg]	Dimensions: Control module H x W x D* [mm]	Control module weight [kg]	Uniform length ± 5 °C [mm]	Max. power [W]
				for use in air [mm]	for use with modified atmosphere [mm]						

High Temperature Vertical Split Tube Furnace HTRV-A

HTRV-A __/70/120	1600	70	120	470	910	700 x 700 x 890 (closed with stand)	65	850 x 560 x 500	60	50	4800
HTRV-A __/70/250	1600, 1700	70	250	600	1040	800 x 600 x 890 (closed with stand)	75	850 x 560 x 500	90	125	6000
HTRV-A __/70/500	1600, 1700	70	500	850	1290	1050 x 700 x 890 (closed with stand)	120	850 x 560 x 500	90	250	13000
HTRV-A __/70/700	1600, 1700	70	700	1050	1490	1250 x 800 x 990 (closed with stand)	170	850 x 560 x 500	120	350	19000
HTRV-A __/100/500	1600, 1700	100	500	850	1290	1050 x 800 x 990 (closed with stand)	140	850 x 560 x 500	120		13000
HTRV-A __/100/700	1600, 1700	100	700	1050	1490	1250 x 800 x 990 (closed with stand)	170	850 x 560 x 500	120		19000

i Please note:

- Heat up rate when using an optional ceramic work tube must be limited to 5°C/min
- The power supply is based on 200 – 240 V for 1 phase and 380 – 415 V for 3 phase power
- Minimum uniform length in horizontal furnace with insulation plugs fitted at 100°C below max. temperature

- Maximum continuous operating temperature is 100°C below maximum temperature
- * Further to the depth of the control module 150 mm for the power plugs and other plugs needs to be added

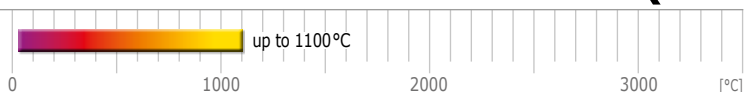

HTR – Rotary Reactor Tube Furnaces

The HTR furnaces combine in a laboratory scale unit many of the advantages of a fluidised bed reactor with those of a rotary kiln.

The sample is simultaneously heated and mixed under a controlled atmosphere. This overcomes the longer reaction times required in standard chamber or tube furnaces.



HTR 11/150

Standard features

- 1100 °C maximum operating temperature
- Carbolite Gero 301 PID controller with single ramp to setpoint and process timer
- Developed in partnership with the Imperial College of Science & Technology, London
- Heating is provided by long life, rapid heating, resistance wire elements mounted in rigid, half cylindrical vacuum formed insulation modules
- Quartz reaction vessel included as standard
- The fluted internal surface of the quartz reactor ensures thorough mixing as the variable speed electric drive system oscillates the reactor tube through 315°
- A positive break safety interlock switch cuts power to the elements when the heating chamber is open
- Gas enters the reactor through a flexible silicon rubber tube
- A 30 mm flow meter for nitrogen is provided
- A single seal gasket directs the reactor exhaust into a removable stainless steel exhaust box from where a gas outlet allows piping to an extraction system

Options (specify these at time of order)

- A range of sophisticated digital controllers, multi-segment programmers and data loggers is available. These can be fitted with RS232, RS485 or Ethernet communications (see pages 106 – 111)
- Over-temperature protection (recommended to protect valuable contents & for unattended operation)
- Single or multiple flow meters for different gases
- Optional inconel reactor

Technical data

CGH	Max. temp. [°C]	Heat-up time [mins]	Max. continuous operating temp. [°C]	Cooling time with lid open [mins]	Dimensions: Reaction chamber dimensions [mm]	Dimensions: Reaction chamber capacity [ml]	Dimensions: Oscillation frequency per min	Dimensions: Rotation in each direction	Dimensions: External H x W x D [mm] lid down	Dimensions: External H x W x D [mm] lid open	Max. power [W]	Holding power [W]	Thermocouple type	Weight [kg]
HTR 11/75	1100	11	1000	15	75 x 100	50	1 to 8	315°	480 x 1140 x 550	800 x 1140 x 680	1500	400	K	40
HTR 11/150	1100	21	1000	15	150 x 200	700	1 to 8	315°	540 x 1300 x 900	950 x 1300 x 900	3000	1000	K	95

i Please note:
- Holding power is measured at continuous operating temperature

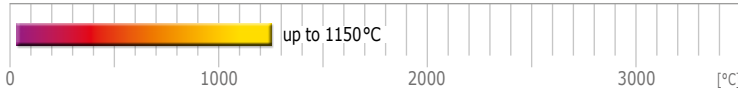

RHST & RHZS – Rotating Horizontal Split Tube Furnaces

The range of Carbolite Gero horizontal rotating tube furnaces offers the benefits of simultaneous heating and mixing of the sample, in addition to the use of an inert atmosphere.

The furnaces are suitable for continuous material processing. Residence time in the heated zone depends on the degree of inclination and the rotating speed (which can be controlled by the customer) and the length of the working tube, in addition to the flow properties of the material.

The design of the split furnace, drive system and feeder/ collection assemblies allows the work tube to be easily removed and replaced.



RHZS 11/75/900 with optional heavy duty feeder and inert gas package

Standard features

- 1150 °C maximum operating temperature; normal operating temperature range 650 °C - 1050 °C
- Heated lengths of 600 mm and 900 mm
- Single zone models fitted with Carbolite Gero 301 PID controller with single ramp to setpoint
- 3-zone models fitted with Carbolite Gero 301 digital PID controller with single ramp to setpoint, digital display and process timer for centre zone. End zone control is provided by 2132 slave controllers
- Single or 3-zone models
- Accepts work tube with inner diameter of 75 mm
- Adjustable inclination and rotation speeds offers flexibility of residence time
- Work tube rotation speed 1.5 to 10.0 revolutions per minute
- 5 litre capacity vibratory feeder and hopper
- The temperature controllers and associated equipment are housed within the integral control box
- Wire elements in high quality vacuum formed insulation ensure fast heat up, excellent temperature uniformity and short cool down times

The single zone and 3-zone split tube furnaces have a maximum operating temperature of 1150 °C. All models are available with heated lengths of either 600 mm or 900 mm. The angle of inclination can be easily adjusted between horizontal and 10°. The ceramic (IAP) work tube has an inner diameter of 75 mm. A safety switch automatically prevents heating and tube rotation when the furnace is opened.

It is essential to discuss your application with Carbolite Gero to ensure the suitability of the material for use in this equipment. Carbolite Gero cannot accept responsibility for your process due to the possibility of the material becoming sticky when heated and therefore not flow through the work tube.

Options (specify these at time of order)

- Quartz (up to 1100 °C) or metallic (up to 800 °C) work tubes
- 5 litre capacity heavy duty vibratory feeder and hopper
- Inert gas packages available on request

Technical data

CGH Model	Max. temperature [°C]	Dimensions: Max. inner Ø accessory tube [mm]	Dimensions: Heated length [mm]	Work tube length [mm]	Dimensions: External H x W x D [mm]	Max. power [W]
Single Zone Rotating Horizontal Split Tube Furnace RHST						
RHST 11/75/600	1150	75	600	1500	1500 x 2200 x 550	3800
RHST 11/75/900	1150	75	900	1500	1500 x 2200 x 550	5500
3-Zone Rotating Horizontal Split Tube Furnace RHZS						
RHZS 11/75/600	1150	75	600	1500	1500 x 2200 x 550	3800
RHZS 11/75/900	1150	75	900	1500	1500 x 2200 x 550	5500

i Please note:
 - Maximum continuous operating temperature is 100 °C below maximum temperature
 - Heat up rate when using an optional ceramic work tube must be limited to 5 °C/min

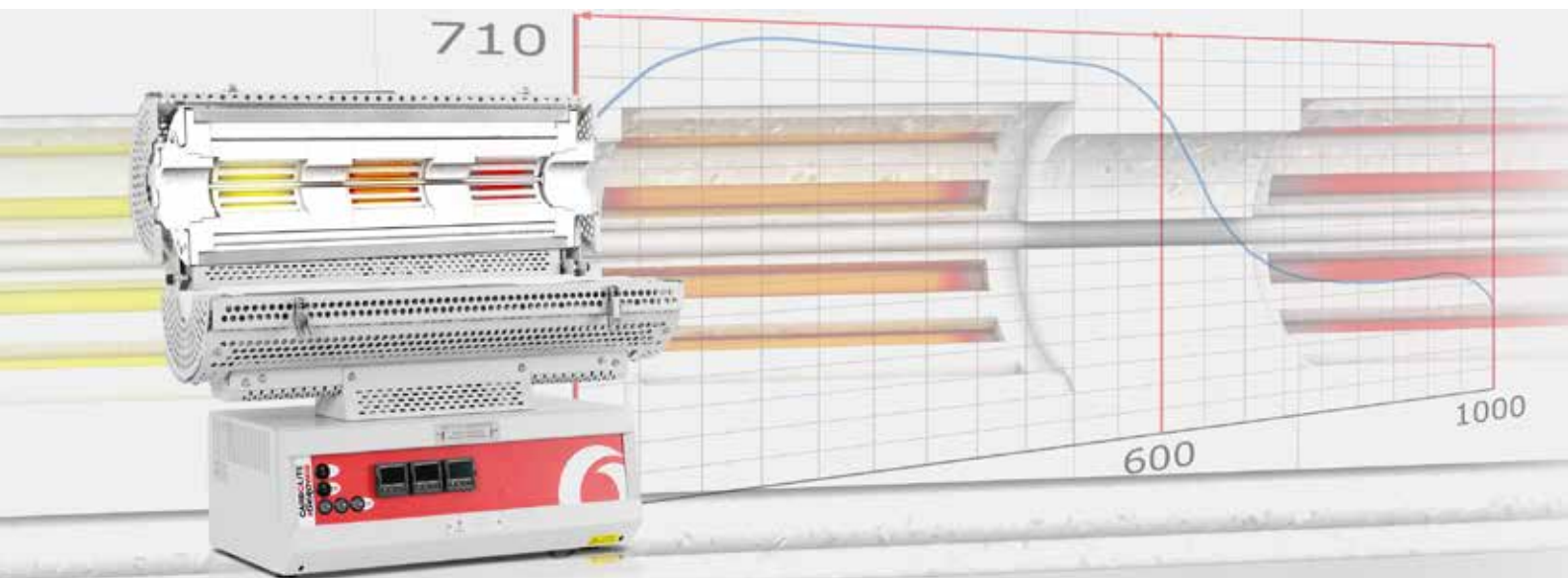

Gradient Tube Furnaces

The Carbolite Gero range of horizontal gradient tube furnaces are design to provide a temperature ramp along the length of a work tube.

A gradient tube furnace is divided into a number of heating 'zones' along the length of the furnace. Each zone has its own individual temperature controller which can be set to independent temperatures, achieving a pre-determined temperature profile along the work tube.

Some heat will naturally transfer between adjacent heating zones and therefore zone barriers are employed to minimize this effect. Examples of heating profiles are shown on each product page.

Chemical vapour transport (CVT) and physical vapour transport (PVT) reactions

- The gradient furnace can be used to heat a reactor tube to provide the two distinct temperatures required in chemical vapour transport reactions
- Materials are vaporized in the hotter zone and condense in the cooler zone
- Extended tube furnace packages options are available to provide a sealed environment for this process
- Vacuum pump packages are also available if vacuum pressure is required
- High quality single crystals can be grown using this equipment.

Chemical vapour transport (CVT) and physical vapour transport (PVT) reactions

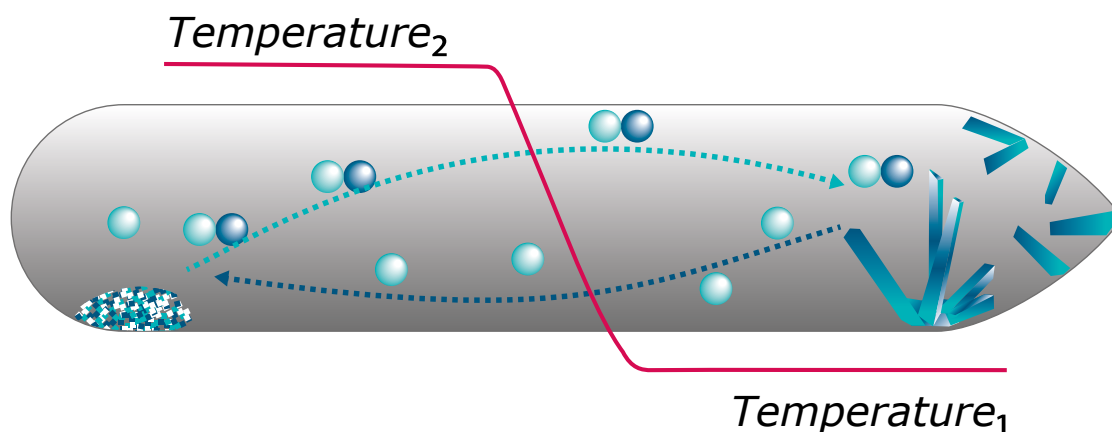

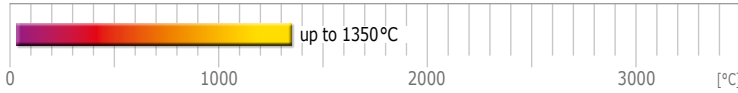

AZ – 8-Zone Tube Furnaces

The AZ is an eight zone tube furnace for controlled temperature profiles. These zones can be used to generate temperature profiles along the heated length of the furnace.

With eight zones, thick insulation, and highly symmetrical winding of the heating elements throughout the entire AZ furnace, a uniformity of better than $\pm 5^\circ\text{C}$ is achieved. A key advantage of the eight individually controlled zones is the extension of the uniform length inside the furnace. Additionally, the temperature profile can be precisely controlled for linear increases, peaks, or other user defined profiles. One process well suited for the AZ tube furnace is chemical vapour deposition as a temperature gradient can be established in the furnace for evaporation of precursor material at the high temperature end zone and sublimation of the vapour on to the substrate at the cooler temperature end zone. All zones are individually controlled and monitored with thermocouples.



AZ 13/110/1000: This picture shows the high vacuum equipment and touch panel controller option

Standard features

- Similar construction to FHA / FHC tube furnaces on page 64
- Eight-zone control for variable heating profiles
- Gradients, linear increase/decrease etc. of temperature along the heated length
- Extended uniform temperature distribution
- Short heating and cooling rates
- Automatic operation
- Data recording for quality management
- Retransmission of setpoint

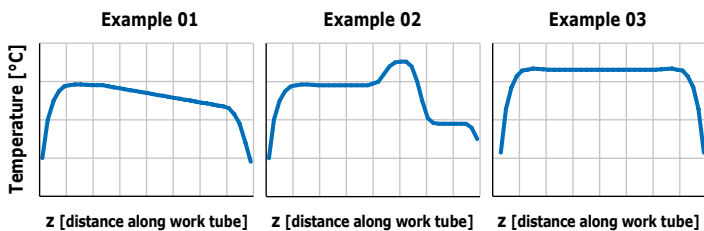

Three typical possible temperature profiles inside the furnace. The eight zones give maximum flexibility.

Options (specify these at time of order)

- A range of sophisticated digital controllers, multi-segment programmers and data loggers is available. These can be fitted with RS232, RS485 or Ethernet communications (see pages 106 – 111). Please note that special controllers may be needed for this model
- Over-temperature protection (recommended to protect valuable contents & for unattended operation)
- Wide choice of tube diameters and materials is available. See pages 112 – 113 for tube materials and dimensions
- 'L' stand for vertical usage
- Insulation plugs & radiation shields to prevent heat loss & improve uniformity (see page 117)
- Modified atmosphere and vacuum assemblies are available (see page 117)
- Vacuum packages with a choice of rotary vane pump or turbomolecular pump are available (page 118)
- Complete automation by Siemens SPS control with touch panel and mass flow controller for the gases on request
- Other diameters and heated lengths on request

Technical data

CGN	Max. temp. [°C]	Dimensions: Max. Diameter accessory tube [mm]	Dimensions: Heated length [mm]	Dimensions: External H x W x D* [mm]	Transport weight** [kg]	Max. power [W]	Voltage [V]	Current [A]	Series fuse [A]
AZ 13/32/360	1350	32	360	990 x 1800 x 500	500	1500	400 (3P)	3 x 4	3 x 16
AZ 13/50/430	1350	50	430	990 x 1800 x 500	550	2900	400 (3P)	3 x 9	3 x 16
AZ 13/80/810	1350	80	810	990 x 1800 x 500	600	7300	400 (3P)	3 x 12	3 x 16
AZ 13/110/1000	1350	110	1000	1200 x 1800 x 520	650	11300	400 (3P)	3 x 19	3 x 25

i Please note:
- Maximum continuous operating temperature is 100°C below maximum temperature

*Small models are supplied with a separate control box
**Max. weight including a high vacuum pumping station

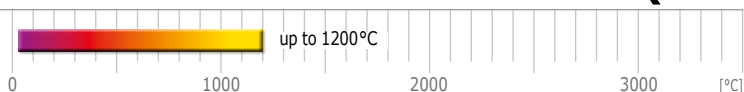

Compact Gradient Split Tube Furnace

These compact split tube furnaces are specifically design to provide a temperature gradient along the length of the heated zones. They use free radiating wire elements embedded within the insulation of the furnace body. The benefit of this design is its flexibility; with the use of tube adapters the same furnace can be used with a variety of tube diameters.

The EZS-3G 12/600B has three independent zones and the HZS-2G 12/425 has two independent zones. They are both split tube furnaces that comprises a furnace body which is hinged and split into two halves along its length. This makes exchange of work tubes easier and also enables the furnace to be used with reactors or work tubes where end flanges would make insertion into a non-split furnace difficult. The 3-zone EZS-3G furnace includes 75 mm long unheated zone barriers between the three 150 mm heated zones and the HZS-2G furnace includes a 25 mm long unheated zone barrier between the two 200 mm heated zones. Each heated zone has its own temperature controller and thermocouple. This range of tube furnaces does not include an integral work tube which must be selected as an additional item. The work tube length is dependent on the application, for example, for use with modified atmosphere or vacuum; this information can be found on pages 112 – 113. The use of a separate work tube has the advantage of protecting the heating elements from damage or contamination.

Note: The temperature gradient achievable is influenced by work tube diameter. Larger gradients will be achieved with smaller diameter work tubes because heat transfer between zones will be less.



HZS-2G 12/425



EZS-3G 12/600B

Standard features

- 1200°C maximum operating temperature
- Each zone has a Carbolite Gero 3216CC digital PID controller with single ramp to setpoint, digital display and process timer
- The EZS-3G 12/600B. Overall heated length of 600 mm divided into three 150 mm heated zones with a 75 mm unheated zone barrier
- HZS-2G 12/425. Overall heated length of 425 mm divided into two 200 mm heated zones with a 25 mm unheated zone barrier
- Accepts work tubes with outer diameters up to 110 mm
- Wire elements in high quality vacuum formed insulation ensure fast heat up, excellent temperature control and short cool down times
- Furnace splits into two halves and accommodates tubes or samples fixed into a test rig
- Model HZS-2G is a split configuration horizontal furnace with a separate control module on a 2 metre conduit
- Model EZS-3G is a horizontal split configuration

Options (specify these at time of order)

- A range of sophisticated digital controllers, multi-segment programmers and data loggers is available. These can be fitted with RS232, RS485 or Ethernet communications (see pages 106 – 111)
- Dual over-temperature protection (recommended to protect valuable contents & for unattended operation)
- A range of additional work tubes (pages 112 – 113), end seals (page 116) and work tube packages (pages 114 – 115) is available for use with modified atmosphere and/or vacuum
- Vacuum packages with a choice of rotary vane pump or turbomolecular pump are available (page 118)
- Wide choice of tube diameters and materials is available.
- See pages 112 – 113 for tube materials and dimensions
- Insulation plugs and radiation shields to prevent heat loss

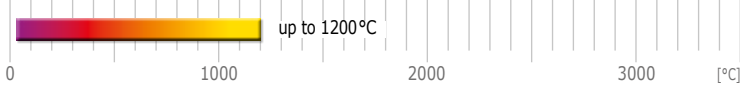

Heat treatment

A sample could be moved between two temperature zones to achieve a desired heat cycle without waiting for a single zone furnace to heat or cool.

Temperature Gradient.

80 mm OD worktube.

Setpoints: **zone 1: off, zone 2: 1100 °C**

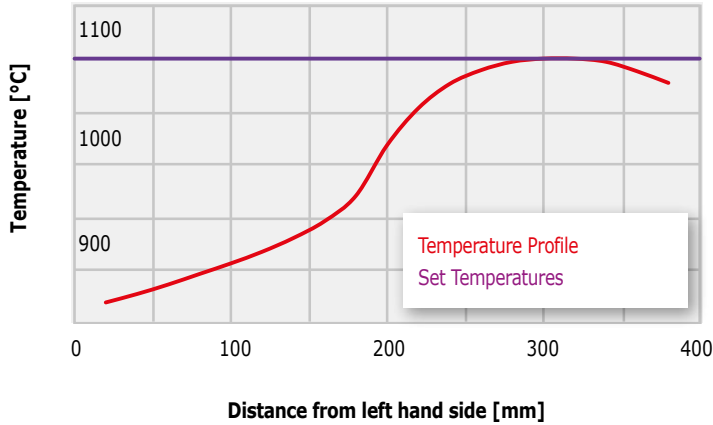

Temperature Gradient.

80 mm OD worktube.

Setpoints: **zone 1: 1000 °C, zone 2: 1100 °C**

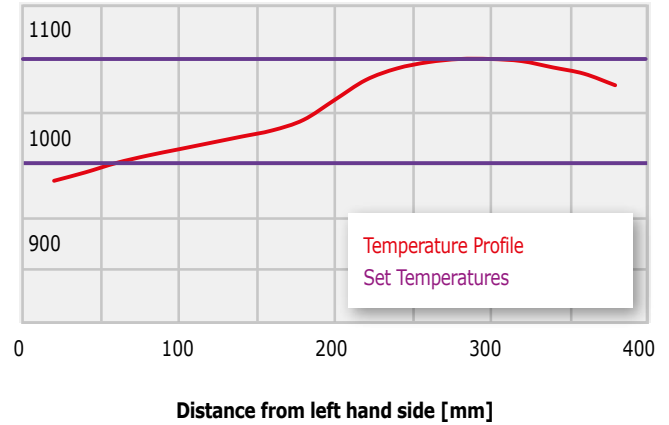

Temperature Gradient.

60 mm OD worktube.

Setpoints: **zone 1: 1100 °C, zone 2: 950 °C, zone 3: 800 °C**

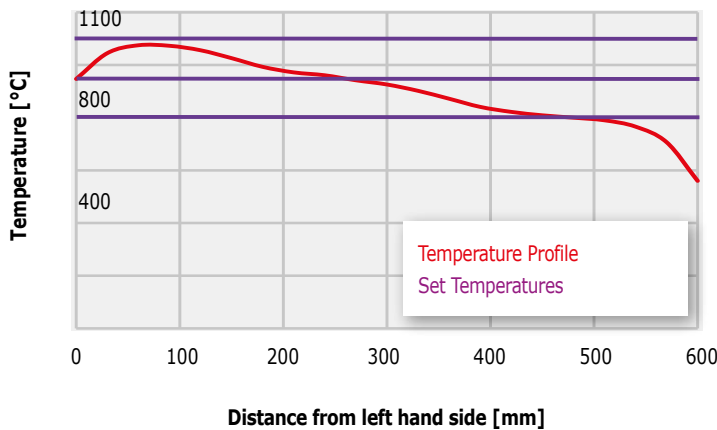

Temperature Gradient.

60 mm OD worktube.

Setpoints: **zone 1: 1100 °C, zone 2: off, zone 3: 400 °C**

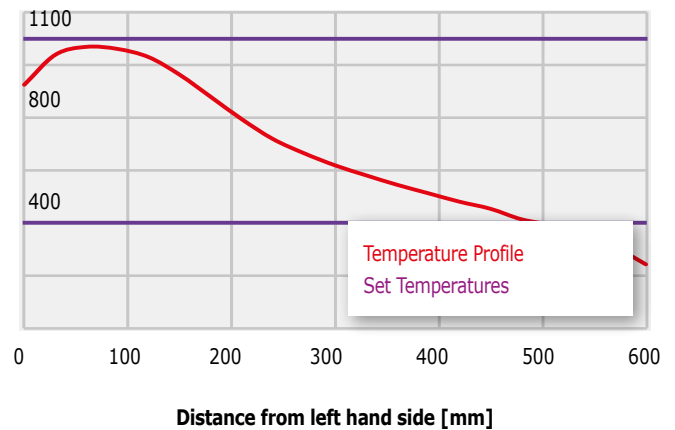

Technical data

Model	Max. temp. [°C]	Heat-up time [mins]	Dimensions: Max. outer Ø accessory tube [mm]	Dimensions: Overall heated length [mm]	Dimensions: Furnace body length [mm]	Recommended tube length		Dimensions: External Furnace H x W x D [mm]	Dimensions: Control module H x W x D [mm]	Max. power [W]	Hold-ing power [W]	Ther-mo-couple type	Weight [kg]
						for use in air [mm]	for use with modified atmosphere [mm]						
EZS-3G 12/600B	1200	55	60	600	-	750	1050	560 x 765 x 390	-	2000	-	N	20
HZS-2G 12/425	1200	45	110	425	550	600	900	350 x 550 x 410	222 x 370 x 376	2000	900	N	33

Application Specific Furnaces

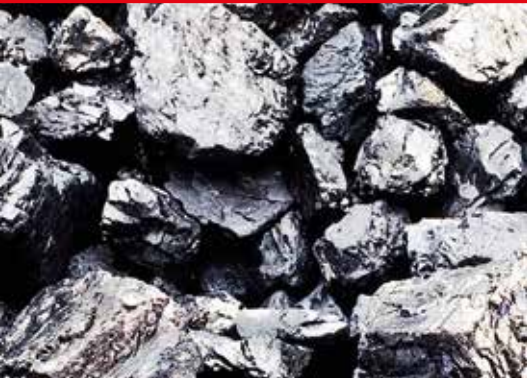

Application Specific Furnaces	Models	Page
Coal and Coke Test Equipment		94
Asphalt Binder Analyser	ABA	96
Thermocouple Calibration Furnace	PTC	97
Carbon-14 and Tritium Furnace	MTT	98
Dental Furnace	CDF	99
Cupellation Furnaces	CF	100
Smelting Furnaces	SCF	101
Vacuum, Inert and Reactive Gas Furnaces up to 3000 °C		102
Custom Designed Ovens & Furnaces up to 1800 °C		103

Coal and Coke Test Equipment

The range of coal and coke tests carried out in a furnace or oven has grown over many years, and Carbolite Gero has responded to the requirements of each new standard by designing a furnace to suit the specific requirements of each test method. As a result, Carbolite Gero products have become established as the standard equipment used in many coal laboratories, inspection companies, power plants and steelworks throughout the world. The range includes international coal and coke testing and iron ore evaluation test methods, including ISO, ASTM, EN, BS, and DIN. Some examples follow, but this is not a complete list.



Coal, Coke & Iron Ore Testing Furnaces

In addition to the equipment shown in this catalogue, Carbolite Gero manufactures a comprehensive range of furnaces for coal, coke and iron ore testing. A new catalogue is available to download from our website, or enquire at info@carbolite-gero.com.

Coal ashing furnaces

The AAF range of ashing furnaces suits many coal (and other materials) ashing tests, including ISO 334 & ISO 1171:2010 Solid mineral fuels – determination of ash, ASTM D2361 & D3174-04(2010) Standard Test Method for Ash in the Analysis Sample of Coal and Coke from Coal, BS 1016 part 4.

- Maximum temperature 1100 °C
- Continuous preheated airflow, to ensure temperature uniformity of better than $\pm 10^\circ\text{C}$ throughout the uniform volume
- Constant airflow held close over the samples to promote burning (AAF 11/3 and AAF 11/7 models have 4-5 air changes per minute)
- Traditional muffle heated chamber gives good resistance to abrasion and vapour attack (AAF 11/3 & AAF 11/7)
- A range of sophisticated controllers and programmers is available, along with data logging equipment



Coal ash fusibility furnaces (CAF G5)

The CAF G5 is designed to test coal ash fusibility and optionally the increasingly popular determination of biomass or solid recovered fuels testing and conforms to the Standards ISO 540:2008; ASDTM D 1857 / D1857M - 04 (2010); DIN 51730:2007-09; DD CEN/TS 15370-1:2006 (biomass) and PD CEN/TR 15404:2010 (SRF)

- 1600 °C tube furnace with integral SiC elements
- 3508P1 automatic temperature programmer with multiple PID control
- Analysis software which can be used in fully automatic or manual modes
- Software zoom function to enable accurate post-test analysis of individual samples with improved resolution
- Tests up to 8 test pieces at any one time
- One configurable grid assigned to each test piece



Carbon anode reactivity test furnace for testing in CO₂ or air

Custom built units to determine the reactivity of carbon anodes used in the production of aluminium in either CO₂ or Air. Used for testing in compliance with the requirements of ISO 12981-1, BS 6043-2.20.1 or ISO 12982-1.

- Maximum temperature: 1000 °C
- Heated length 200 mm
- Maximum outer dimension of accessory tube 40 mm
- External dimensions (H x W x D): 660 x 660 x 475 mm



Iron ore reducibility – ISO 4695 – 4696-1 Combined Test Unit

Reducibility may be defined as a measure of the ease with which oxygen combined with iron can be removed from natural or processed iron ores by a reducing gas, which is expressed as the rate of reduction at an atomic ratio O/Fe = 0.9, relative to the iron (III) state. Test consists of isothermal reduction of a test portion at a specified size range in a fixed bed at a temperature of 950 °C using a reducing gas consisting of CO and N₂

- Maximum temperature: 1100 °C
- Three heated zones over 700 mm
- Balance to determine the loss in mass of the reduced sample with a resolution of 0.1 g connected to the retort during the entire process cycle.
- Dual loop cascade control
- Supplied with retort
- Over-temperature protection
- Flame failure gas safety system



Moving wall coke test oven – 227 kg

The moving wall test oven was developed in close conjunction with UK Coal Research Establishment. The oven is designed for testing suitably granulated and graded coals for coking under accurately controlled conditions. The oven chamber is designed to allow the pressure generated during the coking to be exerted against a fixed wall on one side of the chamber and a moving wall on the other. The pressure is measured by a load transducer actuated by the moving wall.

- Maximum temperature: 1300 °C
- Nominal charge weight: 227 kg (500 lb)
- Optional afterburner
- Multi-function control, recording and visualisation in a single process with colour touchscreen display
- Large internal data archive, with choice of secure logging or CSV





ABA – Asphalt Binder Analyser

The ABA 7/35B is designed to measure the asphalt binder content of hot mix asphalt (HMA) using loss on ignition, in accordance with AASHTO T 308-10, ASTM D6307-10 & BSEN 12697-39:2012.

The integral microprocessor controlled weighing and calculation system is configurable to allow variations to the standard test method. Test result reports are available in both printed and software format. The high temperature afterburner minimises the production of noxious waste fumes. Supplied complete with 2 sets of sample baskets.



ABA 7/35B
(mounted on optional
floor stand)

Standard features

- 750°C maximum operating temperature
- Designed to measure asphalt binder content by loss on ignition
- Avoids the health, environmental & waste management issues & expense associated with the older solvent extraction methods
- Reduced emissions due to high temperature afterburner
- Controlled via a multi-lingual touchscreen interface
- Supplied as standard with English, Spanish, French, Chinese, Italian & Russian language display. Other languages are available to order
- Automatic calculation of final sample weight & binder % result
- Adjustable aggregate correction factor
- Precise weight measurements displayed to 0.1 g resolution
- Has the capacity for large sample sizes for more accurate results (maximum sample weight 4.5 kg)
- Average test times from 20 mins for 6 mm aggregates, to 45 mins for 40 mm aggregates
- Permanent (dot-matrix) printed reports
- USB data output compatible with most spread sheets
- Easy naming, storage & recall of recipes that can be transferred between ABA 7/35B units
- Simplified menu structure with secure 'Supervisor' & 'Operator' settings

- 1) LCD touchscreen control
- 2) Integral fan assisted high-temperature afterburner greatly reduces emissions
- 3) Safety circuits warning lamps
- 4) Rapid heating main chamber with robust 1 mm Ø wire elements
- 5) Integral balance measures loss on ignition to 0.1 g resolution
- 6) Automatic capture of initial weight data is possible from an external balance by RS232 cable
- 7) Optional flat pack floor stand
- 8) Control panel with:
 - Instrument on/off switch
 - Printer on/off switch
 - Safety circuits test switch
 - Afterburner heating lamp
 - Main chamber heater lamps
 - USB data output
- 9) Printer

Technical data

CGH Model	Max. temperature [°C]	Dimensions: Internal H x W x D [mm]	Dimensions: External H x W x D [mm]	Max. power [W]	Thermocouple type	Weight [kg]
ABA 7/35B	750	220 x 350 x 450	980 x 600 x 775 (Bench-top or optional stand)	8000	K	120

i Please note:

- The oven is rated at 8 kW for operation on 208/240 V, 50/60 Hz, three or single phase. Please state mains supply when ordering

- The oven holding power is approximately 3 kW

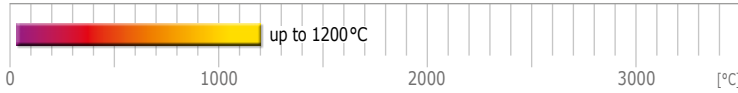

PTC – Thermocouple Calibration Furnaces

The PTC thermocouple calibration furnace is designed to provide a high stability portable heat source for the calibration of thermocouples using the comparison method.

Standard features

- 1200 °C maximum operating temperature
- 2132 single ramp PID controller & separate temperature display to 1.0 °C resolution
- High stability heat source with temperature range 400 to 1150 °C
- Accepts thermocouples up to 7.5 mm diameter
- Thermocouple is inserted & compared to the PTC 12/20's displayed temperature
- The special work tube design provides better temperature uniformity than is typical for a furnace of this size
- The metallic work tube is earthed for operator safety when testing metal sheathed mineral insulated mineral thermocouples
- Rapid heat up and stabilisation makes it ideal for use in the laboratory or on site
- Portable & self-contained



PTC 12/20/150

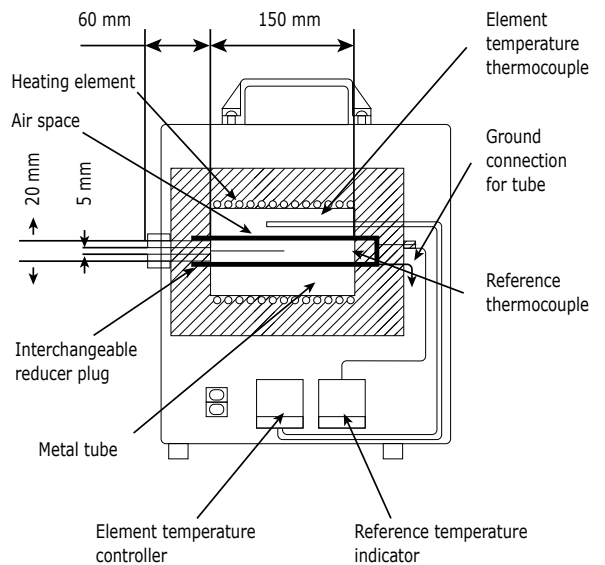

Options (specify these at time of order)

- Factory calibration certificate stating the error between the workspace temperature & the displayed value at 700 °C, 900 °C & 1100 °C
- A UKAS traceable calibration certificate for customer defined setpoints is available
- A UKAS calibrated thermocouple is available

Technical data

Model	Max. temperature [°C]	Heat-up time to 1150 °C [mins]	Temperature range [°C]	Stability [± °C]	Dimensions: Heated length [mm]	Dimensions: Fixed tube inner diameter [mm]	Dimensions: External H x W x D [mm]	Max. power [W]	Thermocouple type	Weight [kg]
PTC 12/20/150	1200	20	400 to 1150	0.5 @ 1150°C	150	20	399 x 310 x 225	1100	N	8.8

i Please note:
- Maximum continuous operating temperature is 50 °C below maximum temperature

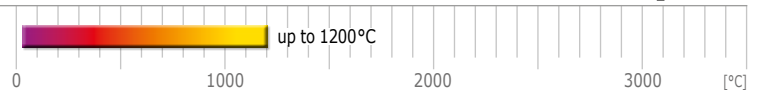

MTT – Carbon-14 and Tritium Furnaces

This apparatus uses catalyst assisted combustion techniques to give a clean and precise approach to extracting carbon-14 & organically bound tritium or 'fixed tritium', e.g. tritium contained in concretes, steels and graphites, as well as 'free water'.

A catalyst is used to ensure complete combustion of all thermal decomposition products. These are captured for liquid scintillation assay. This technique gives greater confidence of complete combustion than 'wet oxidation' techniques and avoids coloured contamination of scintillation media by botanical samples. Computer control enables remote operation of multiple or individual units even in hazardous areas.



MTT 12/38/850

Standard features

- 1200 °C maximum operating temperature
- 3508P1 20 segment programmable temperature control for sample specific combustion protocols
- 2-zone tube furnace configured for capture by combustion of organically bound carbon-14 and tritium
- Large sample capacity up to 20 ml provides accurate determinations
- Originally developed in partnership with AEA Technology
- 2 quartz glass work tube assemblies
- 6 combustion boats
- Three sets of glass gas bubblers (12 in total)
- All connectors including the molecular sieve waste aerosol trap
- Unique catalyst optimisation manifold
- 6 copper wire catalysts
- Over-temperature protection of both heated zones
- RS485 communications & control
- Eurotherm iTools allows software storage & recall of specific sample protocols
- Free from plastic or rubber components into which tritium can migrate
- A comprehensive process instruction manual

Options (specify these at time of order)

- Additional sets of bubblers (sets of 4)
- Additional sets of combustion boats (sets of 6)
- Additional work tubes
- Additional copper catalyst (sets of 3)

Technical data

CGH Model	Max. temperature [°C]	Dimensions: Heated length [mm]	Dimensions: External H x W x D [mm]	Dimensions: Furnace body length [mm]	Max. power [W]	Thermocouple type	Weight [kg]
MTT 12/38/850	1200	850	430 x 900 x 375	900	3100	N	60

i Please note:
 - Maximum continuous operating temperature is 100°C below maximum temperature

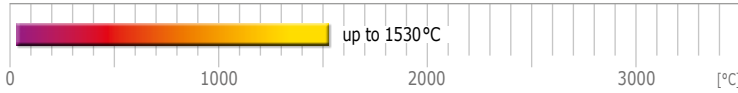

CDF – Dental Furnaces

The Carbolite Gero dental furnace is designed to provide easy sintering of zirconia (yttrium stabilised zirconium oxide) dental crowns and frameworks.

The furnace is equipped with three robust high-quality heating elements made of silicon carbide. In contrast to many molybdenum disilicide heating elements these are free of any chemical interaction with zirconium oxide.

Standard features

- 1530 °C maximum operating temperature
- Four program 4-segment 302P4 programmer (4 ramps, 4 dwell times)
- Excellent temperature uniformity and precise temperature control
- Optimised for operation from a standard 16A single phase mains supply
- Uniform heating from non-contaminating silicon carbide elements
- Complete sintering tray & 200 g of zirconium support beads
- One litre capacity chamber



CDF 15/1C

Options (specify these at time of order)

- Spare sinter trays
- Spare sinter support beads

Program Descriptions

The CDF has three programs for sintering frameworks as described below, as well as one freely adjustable program for sintering dental oxide ceramics.

Program 1 – Standard program

Universal sintering program for all common indications.

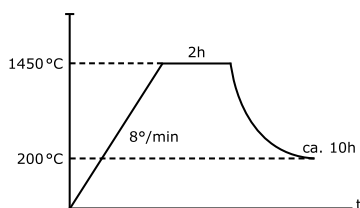

Program 2 – Fast sintering program

Fast sintering program for single units only. With this program the furnace may be charged with a maximum of one sintering tray, otherwise, full sintering of the objects cannot be achieved.

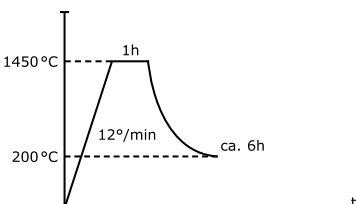

Program 3 – Sintering program with extended cooling

This sintering program has a hold stage at 900 °C with a defined cooling rate. This can be used for large frameworks where the connected residual blank is sintered together with the framework.

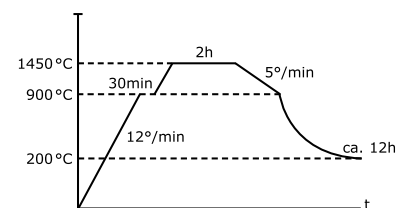

Program 4 – Freely programmable parameters

Four successive segments can be assigned to the free program (no. 4). Each segment contains one heating rate, temperature hold stage and, if defined, one cooling rate. The maximum adjustable sintering temperature is 1530 °C; the maximum heating rate is limited to 12 °C/min. As a default, the program is pre-set to 1500 °C, 2 hours of holding time and a heating rate of 12 °C/min (not specific to any material).

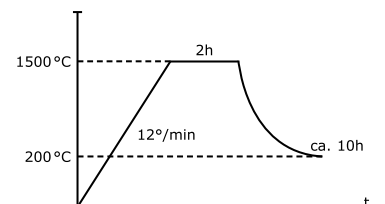

Technical data

CGH	Max. temperature [°C]	Heat-up time [mins]	Dimensions: Internal H x W x D [mm]	Dimensions: External H x W x D [mm]	Volume [litres]	Max. power [W]	Holding power [W]	Weight [kg]
Model								
CDF 15/1C	1530	126	80 x 90 x 150	655 x 385 x 535	1	3100	1145	42

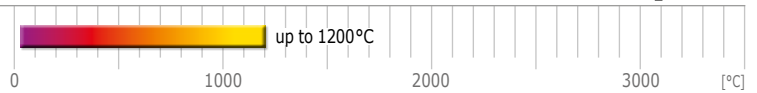

CF – Cupellation Furnaces

The CF cupellation furnaces are designed for the cupellation, or fire assay test, of precious metals, which is a standard test method used to determine their purity.

The furnaces meet the Hallmarking requirements specified by the Convention on the Control and Marking of Articles of Precious Metals (known also as “Precious Metals Convention”, “Hallmarking Convention” or “Vienna Convention”).

The test method produces hazardous vapours. When used within a suitable fume management system, the cupellation furnaces are designed to handle the vapours without exposing the operator to these hazards. The design of the cupellation furnace range ensures protection from the corrosive environment which would damage a conventional furnace.

Carbolite Gero also offers a range of smelting/melting furnaces (see page 101).



CF 24B

Standard features

- 1200 °C maximum operating temperature
- Carbolite Gero 301 controller with single ramp to setpoint & process timer
- Designed for testing using the cupellation method to ISO11426:1999 the standard test method used by the UK Assay Office, a reference quantitative assay method by the International Hallmark Convention
- The airflow, controlled by an adjustable valve, is preheated before entering the work chamber
- Silicon carbide elements mounted above & below the chamber provide even heating of cupels, have good resistance to thermal shock and offer extended working life at high temperatures
- Silicon carbide lined roof and hearth protect the heating elements and resist the corrosive fumes emitted during the cupellation process
- Fumes are extracted through an insulated exhaust duct, with a removable container to collect condensed lead
- Counterbalanced vertical lift door fitted with observation hole
- Element over-temperature protection controller
- Fitted with 7 day, 24 hour time-switch

Options (specify these at time of order)

- A range of sophisticated digital controllers, multi-segment programmers and data loggers is available. These can be fitted with RS232, RS485 or Ethernet communications (see pages 106 – 111)
- Over-temperature protection (recommended to protect valuable contents & for unattended operation)

Technical data

Model	Max. temp. [°C]	Maximum continuous operating temp. [°C]	Dimensions: Internal H x W x D [mm]	Dimensions: External H x W x D [mm]	Dimensions: External with door open H x W x D [mm]	Charge capacity of no. 8 cupels	Charge capacity of no. 6 cupels	Thermocouple type	Max. power [W]
CF 15B	1200	1200	125 x 215 x 270	1055 x 910 x 930* 225 x 600 x 380 (Separate control module)	900 x 910 x 1130*	15	24	R	9000
CF 24B	1200	1200	200 x 250 x 340	2100 x 940 x 1020**	1920 x 940 x 1180**	24	32	R	13000
CF 60B	1200	1200	250 x 400 x 600	2300 x 1190 x 1240**	2000 x 1190 x 1580**	60	90	R	31000

i Please note:
* Bench-mounted, ** Floor-standing

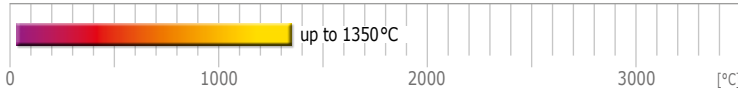

SCF – Smelting Furnaces



SCF 4 with 3216P1 programmer option

The SCF range of top loading crucible furnaces is available in three sizes with a maximum operating temperature of 1400 °C. They are specifically designed for the smelting of precious metals.

The furnaces are robustly constructed from heavy gauge hollow steel section and zinc coated sheet steel panels. Silicon carbide heating elements surround the chamber sides and are protected by silicon carbide tiles. The hearth is constructed from refractory bricks and silicon carbide tiles. The SCF 1 has a single chamber, all other models have twin chambers with separate lids.

Options (specify these at time of order)

- A range of sophisticated digital controllers, multi-segment programmers and data loggers is available. These can be fitted with RS232, RS485 or Ethernet communications (see pages 106 – 111)
- Over-temperature protection (recommended to protect valuable contents & for unattended operation)

Standard features

- 1400°C maximum operating temperature
- Carbolite Gero 301 controller with single ramp to setpoint & process timer
- The horizontal, parallel opening lids open with the hot face away from the user
- Each lid is vented by a 50 mm diameter chimney
- Silicon carbide heating elements protected by silicon carbide tiles
- The hearths of the SCF 4 and SCF 8 models include cast alumina supports to securely hold the appropriate number of crucibles
- The hearths of the SCF 24 and SCF 48 models are the same size but without crucible supports
- A 24 hour, 7 day timer

Technical data

CGH Model	Max. temp. [°C]	Max. continuous operating temp. [°C]	Dimensions excluding handles: External H x W x D [mm]	Dimensions: Each chamber H x W x D [mm]	Dimensions: Control module H x W x D [mm]	Charge capacity	Thermocouple type	Max. power [W]
SCF 1	1400	1350	850 x 905 x 905	440 x 285 x 285	630 x 600 x 490	–	R	15000
SCF 4	1400	1350	1040 x 1230 x 1040	200 x 245 x 500	630 x 600 x 490	4 crucibles 120 x 180 (OD x H mm)	R	15000
SCF 8	1400	1350	1025 x 1350 x 1300	200 x 245 x 760	630 x 600 x 490	8 crucibles 120 x 180 (OD x H mm)	R	24000
SCF 24	1400	1350	1040 x 1230 x 1040	200 x 220 x 500	630 x 600 x 490	24 crucibles 79 x 97 (OD x H mm)	R	15000
SCF 48	1400	1350	1025 x 1350 x 1300	200 x 245 x 760	630 x 600 x 490	48 crucibles 79 x 97 (OD x H mm)	R	24000

Vacuum, Inert and Reactive Gas Furnaces up to 3000 °C

LHTG, LHTM, LHTW top loader vacuum chamber furnace up to 3000 °C

The vacuum chamber furnace range LHTG, LHTM, LHTW furnaces (using Graphite, Molybdenum or Tungsten as heating and insulation material) are typical laboratory furnaces designed for all types of heat treatment processes (eg in material science). They are used for high vacuum applications up to 1×10^{-6} mbar and very pure atmospheres of hydrogen and other gases. The graphite versions have a maximum operating temperature of 2000 °C, but special versions up to 3000 °C can be supplied. All furnaces are available with manual operation as standard but are can be supplied with fully automated control by a SIEMENS PLC with WIN CC visualisation.



LHTW 200-300/22

HTK front loader vacuum chamber furnace up to 2200 °C

The HTK range is available in three different versions (Molybdenum, Tungsten or Graphite) and in up to six different sizes. The smallest designs with 8 litre and 25 litre capacity are usually employed by laboratories for research and development. The 80 litre to 600 litre capacity versions are predominantly used as plant for pilot manufacture and for production. Typical applications include pyrolysis, siliconizing and graphitizing, metal powder injection moulding, tempering of sapphires, sintering of pellets in the nuclear industry, manufacture of radar tubes, metallisation of ceramic components and high vacuum brazing.



HTK 400 GR/22

Metal- and ceramic Injection Moulding (CIM and MIM) & Debinding and Sintering Furnaces

High volume production of complex metal parts is increasingly carried out by metal injection moulding. During this process a metal/binder mixture is filled into precisely preshaped forms. After removal from these forms, the parts then need to be debinded and finally sintered to obtain the desired mechanical properties. For this purpose Carbolite Gero offers optimized products for debinding and sintering like the EBO (optimized for BASF Catamold® feedstock) and the PDS range. The HTK range (see above) is also suitable for the debinding and sintering process as well.



EBO 120/1.5 for catalytic debinding

PDS 120 MO/14 for partial pressure sintering

Vacuum, Inert and Reactive Gas Furnaces up to 3000 °C



With the formation of Carbolite Gero, customers requiring heat treatment processes from 30 °C to 3000 °C have access to a single highly qualified source for equipment. Carbolite Gero instruments work with vacuum, partial pressure, air, controlled pressure and overpressure environments. The equipment can be used with inert gases like argon or nitrogen and also reactive gases such as hydrogen or oxygen. For a comprehensive view of Carbolite Gero products up to 3000 °C please refer to the separate Carbolite Gero catalogue 'Vacuum, Inert and Reactive Gas Furnaces up to 3000 °C'.

On request Carbolite Gero can provide custom solutions for all vacuum chamber furnaces up to 3000 °C by modification of a standard product or custom designing a product to provide a customer specific process solution. Please inquire for consultation.

Custom Designed Ovens & Furnaces up to 1800 °C

GP 450A general purpose oven with rotating mechanism

This is a good example of a mechanical modification of a standard product. In this case the customer required continuous agitation of their samples. The samples are simply clipped onto the fixtures which rotate once the oven door is closed. The fixtures can be rotated slowly with a manual push button to the correct positions to load the samples.

- Testing corrosion inhibitors used in the petroleum industry between 60 and 120 °C
- Rotating mechanism to accept 20 of the customer's reactors on two shafts, directly driven via motor and gearbox
- Independent adjustable rotation speed in the range 1 to 10 revolutions per minute.
- Door closing mechanism using shoot bolt with interlock to stop rotation of mechanism when the door is open



GP 450A

Top hat furnace system with twin retorts

This complete top hat system has two vertical tubular Inconel 601 retorts with a furnace that can heat one retort whilst the other is being prepared or is cooling. The furnace has a parking position when not in use. The system is supplied with a gas safety system to allow the use of hydrogen and can also be used under vacuum.

- Machined retort base plate for vacuum sealing against a water cooled hearth base with twin elastomer seals
- Hydrogen flow interlocked to gas safety system requirements: furnace temperature; minimum flow rates; gas supply pressures; and pre-timed nitrogen purge; gas burn off with flame failure system
- Three heated zones of 200 mm with 25 mm thick insulated zone barriers



Top hat furnace system with twin retorts

Cycling corrosion test furnace with gas system

This is an excellent example of a system which combines a tube furnace, gas control equipment and mechanical modifications. The tube furnace and its integral extraction hood are mounted on wheels and can be moved along the quartz work tube. The rails for the wheels are mounted on the support frame. Mass flow controlled gas supplies are fed into the work tube through end seals together with probe thermocouples. It is used for long term corrosion testing of turbine blades.

- Siemens TP 177B HMI colour touch screen control system with temperature display, gas control and alarm display
- Gas control through mass flow controllers connected to the Siemens control system with flow range 0 to 10 litres per minute
- Mixed gases pass through a humidifier with a maximum flow rate of 4 litres per minute. Deionised water supply required
- Hydrogen and carbon monoxide flow interlocked to furnace temperatures above 750 °C.
- Heavy gauge APM wire heating element cassette suitable for 1300 °C operation



Bespoke cycling corrosion test furnace

Custom Designed Ovens & Furnaces up to 3000 °C



Carbolite Gero can provide custom solutions for all products up to 3000 °C by modification of a standard product or custom designing a product to provide a customer specific process solution.

Common modifications for all products include modifications on fans, mechanical changes, instrumentations and performance validation for aerospace standard AMS2750E, atmosphere control packages, gas preheating, inputs and outputs and higher power heating elements. For a comprehensive view on other modifications specific to ovens, chamber and tube furnaces please refer to the Carbolite Gero Custom Design catalogue.

Product Configurations

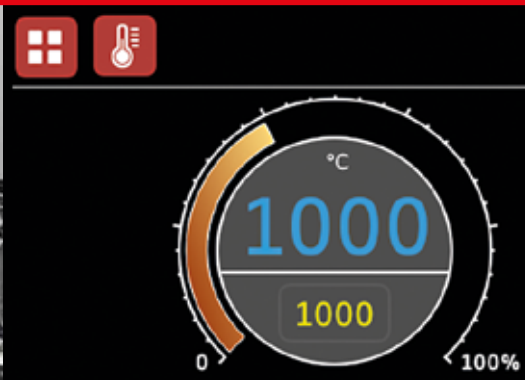
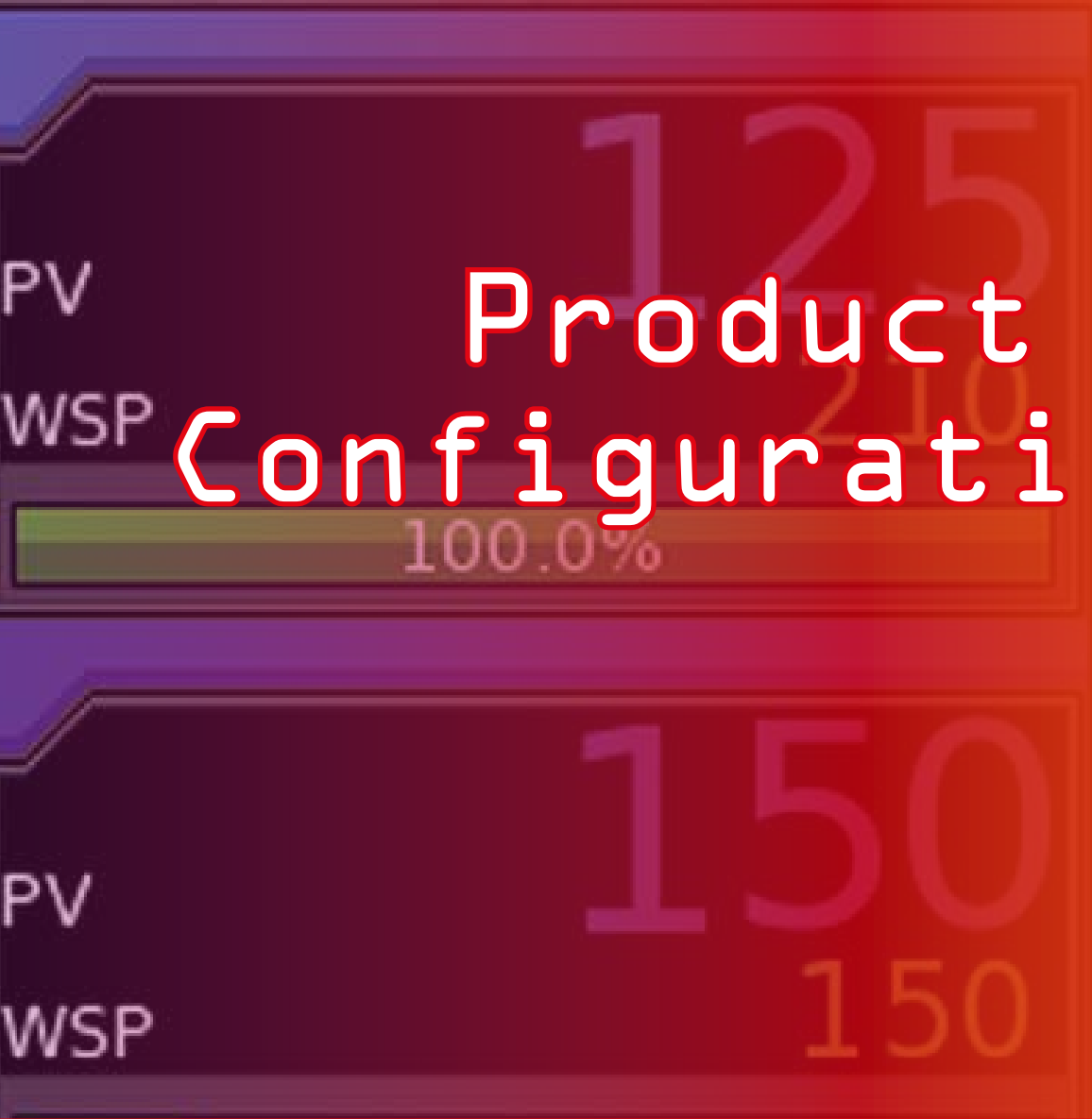

nanodac

Product Configurations	Page
Temperature Control Options	106
Work Tube Selection Guide	112
Work Tube Packages	114
Work Tube Accessories	116
Vacuum Pump Packages for Tube Furnaces	118
Modified Atmosphere Options	120
Power Supply Information	122

The range of high quality PID (Proportional, Integral, Derivative) temperature controllers shown below are fitted to Carbolite Gero products. These controllers provide accurate temperature control that closely follows programmed ramp rates and setpoint temperatures. The full range is not fitted to all products, please see product pages for details.

NEW Touch screen controller

CC-T1 touch screen controller

The CC-T1 touch screen controllers offer programmable control in which 24 segments may be set as ramp, step or dwell and may also be configured to control relays.

The CC-T1 series provides a touch screen interface giving intuitive access to a comprehensive menu including: selection and editing of program profiles; scheduling of programs at a defined date/time; data logging of setpoint and actual temperature; localization of language; user level security. The CC-T1 series can also store and retrieve 10 unique program profiles. Data-logging is to a csv file which is accessed through the adjacent USB port. Ethernet communication is fitted as a standard feature.

When specified with a 3-zone product the control method is user selectable to be either retransmission of setpoint or independent control. With retransmission of setpoint the main zone controller's setpoint is automatically applied to the other zones. When running a program all zones will follow the program profile. With independent control each zones setpoint is set manually.

Standard features

- 4.3" colour touch screen
- Setpoint control
- Program profile control
- 10 unique program profiles saved in memory
- 24 segments per unique program
- Ethernet communication
- Panel mounted USB socket
- Data logging to a USB memory stick in a .csv file format
- Real time clock
- Program schedule start
- Program status indication with estimate end time & date
- Event indication (2 events)
- Control power indication
- User level security
- Dual temperature calibration
- Language setting: English, German, French, Italian, Spanish, Chinese, Russian, Japanese
- 3-zone version: retransmission of setpoint



The new CC-T1 touch screen controller in use.

Options (specify these at time of order)

- Over-temperature protection (independent controller)
- Alarm activation of relays to operate devices such as a door interlock
- Program segment events
- Temperature alarm relay connections
- Cascade control

User level functionality

User level	Functions
Operator	Change temperature setpoint <ul style="list-style-type: none"> • Run pre-configured programs • Run data logging
Supervisor	All of the above plus: <ul style="list-style-type: none"> • Configure and edit programs • Manage alarms
Administrator	All of the above plus: <ul style="list-style-type: none"> • Set language, time and date • Edit data logging settings • Edit settings including calibration and serial communication

Navigation screen

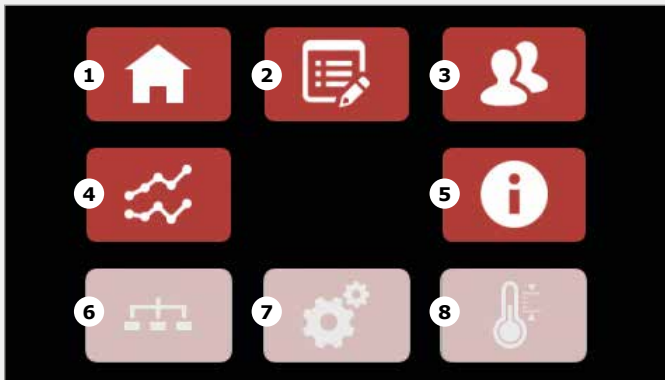

The navigation screen gives easy access to all the CC-T1 functions.

- | | | |
|-----------------|---------------------------|-----------------------|
| 1) Home | 4) Data logging | 7) Settings |
| 2) Program view | 5) Information | 8) Offset calibration |
| 3) User login | 6) Communication settings | |

Home screen single zone

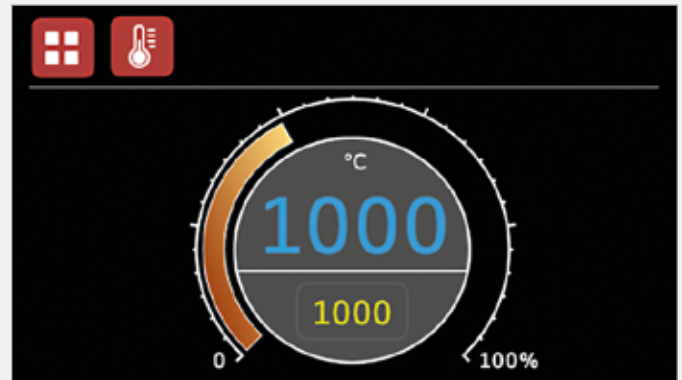

The home screen shows the setpoint, actual temperature and the heating power.

Home screen program running

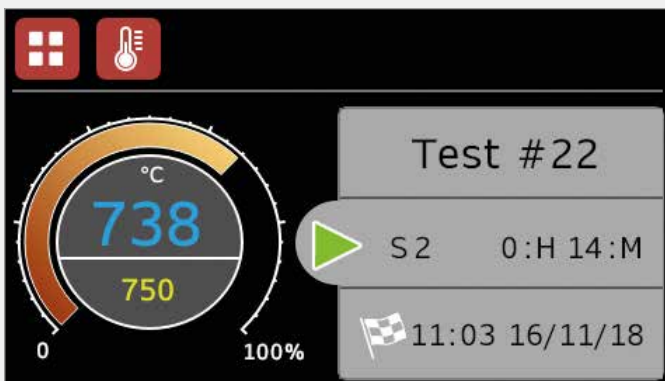

When a program is running the home screen shows a summary of the progress of the program. This includes: the program name; the current program segment and the time remaining in that segment; the end time and date of the program

Home screen 3-zone

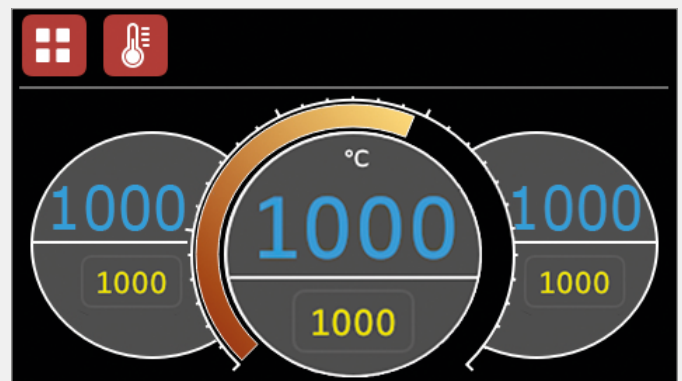

For a 3-zone product the home screen shows the setpoint and actual temperature of each zone. The user can select the end zones to either follow the centre zone temperature or run independently.

Program view screen

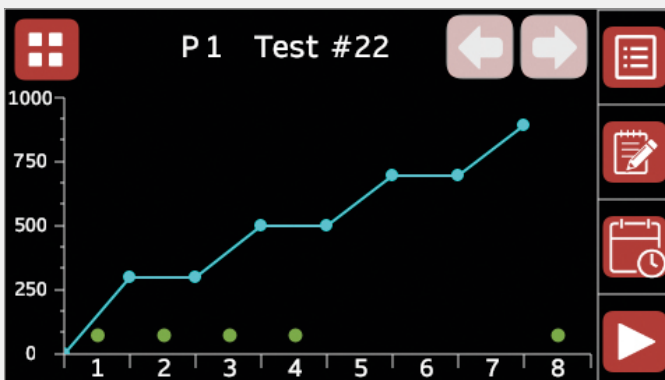

The program view screen shows a graphical summary of the selected program. It also give access to: Program selection; program creation and editing; scheduling a program to run at a specific time and date and running a program.

Data Logging Screen

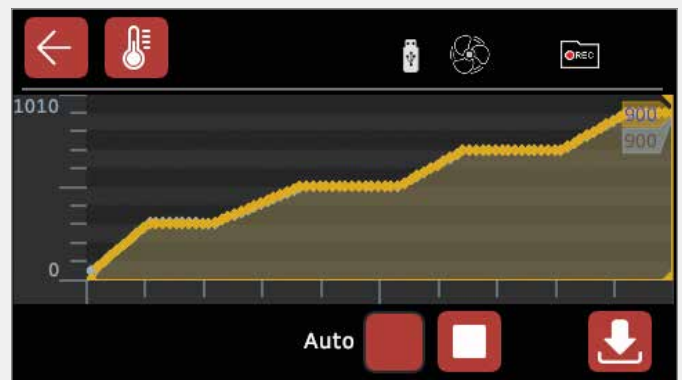

The data logging screen shows a graphical view of the setpoint and actual temperature along with the status of any configured relays. Data is logged to a USB stick in a .csv file format. Data logging can be started manually or automatically when a program is run.

Standard controller

301 Standard controller

The 301 PID controller has a large display mounted behind a smooth wipe-clean membrane and offers a single ramp to set point. It includes a 99 hour process timer which can be programmed for a timed delay at the start of the process or used as a countdown timer.



The 301 provides **precise PID** (Proportional Integral Derivative) control meaning that ramp rates and set points are very closely followed.

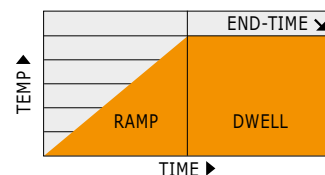

2132 PID controller

Where size limitations don't allow the 301 controller to be fitted, the 2132 is fitted instead. Features a single ramp to setpoint and process timer, which can be programmed for a timed delay at the start of the process or used as a countdown timer.



Options

301 Over-temperature control

This option offers a variable set point to protect either the chamber or the load. Selection of this option provides an additional independent thermocouple and protection circuit which is fully integrated into the 301 controller. Whilst all Carbolite Gero products are designed to fail safe in the event strongly recommended for unattended operation or where valuable loads are to be processed.



3216CC Standard controller

The 3216CC has the same functionality as the 301 product and is fitted as standard where the 301 is not offered. See product pages for details.

R38 Standard controller

The R38 is a simple PID oven controller with a large digital display. The R38 will accurately maintain the set point temperature.



Programmable controllers

3216P1 & 3216P5

These controllers offer programmable control using up to 8 segment pairs, each segment comprising a ramp followed by a dwell; the dwell may be set to zero time. The 3216P1 & 3216P5 have 8 segment pairs. The 3216P5 can also store and retrieve up to 5 separate programs.

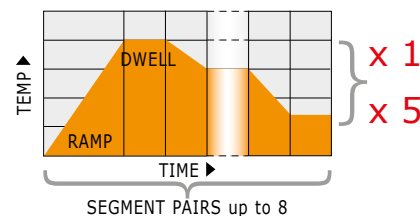

3508P1, 3508P10 & 3508P25

These controllers offer programmable control in which 20 segments may be set as ramp, step or dwell and may also be configured to control relays or logic outputs. The 3508 series provide a comprehensive information display. If precise temperature control is required over a wide range of temperatures, the 3508 series allows the use of multiple PID terms (gain scheduling). This feature is not enabled as standard, but can be activated on request. The 3508P10 and 3508P25 can also store and retrieve 10 and 25 programs respectively.

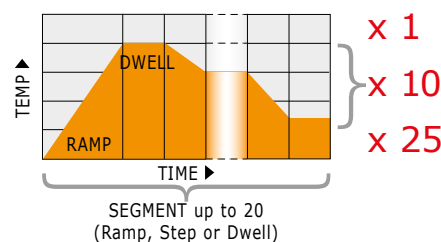

Eurotherm nanodac™

Recorder & PID controller

In this configuration the nanodac™ combines precision PID temperature control, with a fully functional data logger. The full colour display can be changed to display text in English, French, German, Italian or Spanish.

Data is continuously logged into either CSV (comma separated variable) or securely to UHH (Eurotherm Hydra History) files. Data can be archived onto a USB flash drive or via Ethernet to a networked server. Up to 4 channels can be recorded, with up to 14 virtual channels that can be set to record trends, alarms, communications or mathematical functions such as totals or averages.

Logged files can be opened and displayed on a PC, in chart form, using Eurotherm Review Lite software.



In this configuration the nanodac™ can hold up to 100 programs

Recorder & PID programmable controller

In addition to the above this controller offers programmable control in which 25 segments may be set as a ramp, step or dwell and may also be configured to control relay or logic outputs. It stores and retrieves 100 programs.

Additional programs can be saved to, and retrieved from, a networker server via a USB flash drive or Ethernet. The action of up to 3 relays, or logic outputs, can be linked to a program segment; this can be used to switch on external devices such as gas solenoid valves and audible alarms. Note that some configurations may require additional components.

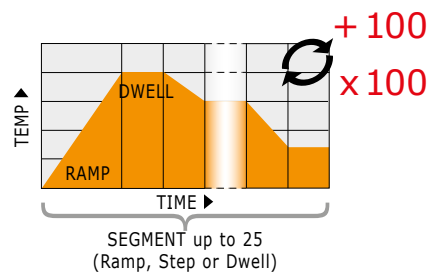

NEW Batch recording option

Batch records form a part of recording history and are identified by messages that are written to the history file indicating when a batch starts and ends, along with additional customisable textual information.

Batches can be initiated directly by the operator, automatically whenever a specific PV value is reached, or remotely via Modbus.

Options

Over-temperature control

This has a variable set point to protect either the furnace, oven or the load. If the main controller is from the 3216, 3508 or nanodac™ series this is provided by the addition of an independent 2132 controller. Whilst all Carbolite Gero products are designed to fail safe in the event of a controller malfunction, over-temperature protection is strongly recommended for unattended operation or where valuable loads are to be processed.



RS232, RS485 and Ethernet communications

- RS232 allows a single controller to communicate with a single computer
- RS485 allows multiple controllers to communicate with a single computer
- Both require, but do not include, suitable PC based software (eg iTools) and connection cables
- RS232 to USB and RS485 to USB converters are available
- 301 controller – RS232 is only available when ordered with over-temperature option (RS485 is not available with the 301 controller)
- 3216 and 3508 series controllers both have the option to add RS232 or RS485 communications
- Ethernet communication is supplied as standard with the nanodac™ controller and is optional in the 3508 series

Cascade control

This feature offers the benefit of precise temperature control of the load. A standard controller operates by sensing the temperature close to the elements. With cascade control the controller's operation includes a second control thermocouple, which is used to sense the temperature of the load. It is essential that the controller is a CC-T1, dual loop 3508 or dual loop nanodac™.

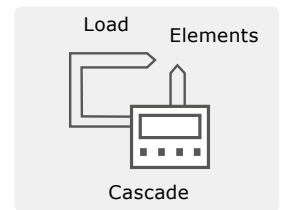

Three zone control

This has the function in 3-zone tube furnaces of extending the length of the uniform heated zone.

Back-to-back control

This configuration is only supplied on Carbolite Gero 3-zone tube furnaces up to 1200°C and where the centre zone controller is a model 301. The end zones follow the centre zone temperature. The centre zone controller has one thermocouple positioned in the centre zone. Each end zone controller has a thermocouple positioned in the end zone, plus a connection to a reference thermocouple positioned in the centre zone. The 'reference' thermocouple is shared by the end zones. If a cooling ramp is required, then a programmable controller with retransmission of setpoint must be specified.

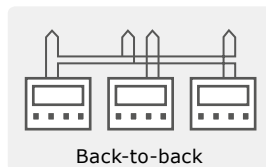

Retransmission of set point

This is standard for SBCF-3, FHC/FZS, HTRH-3 and TZF 1500°C and TZF 1600°C models and can be optionally supplied on all other Carbolite Gero 3-zone furnaces. When the operator adjusts the setpoint of the centre zone controller, the setpoint of both end zones are automatically set to the same value. If the centre zone is a programmer all zones will automatically follow the program. This overcomes the problem of back to back thermocouples attempting to follow a cooling ramp. Each controller has one thermocouple positioned with the tip close to the centre of each zone.

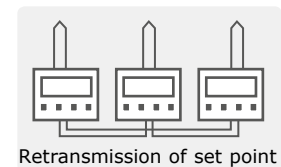

Independent control

This configuration comprises three independent controllers, each with an independent thermocouple in its respective zone. This option is not designed to create a temperature gradient.

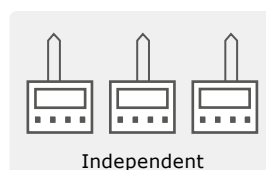

Three zone cascade control

As in single zone furnaces, cascade control allows faster heating of the furnace load and more precise control of the load temperature. A CC-T1, 3508 or nanodac™ controller is required.

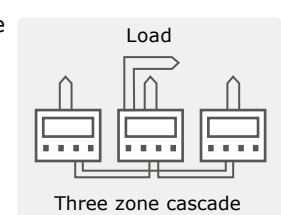

Calibration certificates

The following calibration options can be supplied, each of which is available with a certificate from a UKAS accredited laboratory, which is traceable to a UK national standard

- UKAS traceable certificate for the thermocouple only, calibrated at 3 temperature points, specified by the customer
- UKAS traceable certificate for the temperature controller only, calibrated at 3 temperature points at temperatures specified by Carbolite Gero

- UKAS traceable certificate at 3 temperature points for both thermocouple & temperature controller
- For advice and specifications to comply with AMS2750E (Nadcap) for heat treatment applications, please contact Carbolite Gero

Chart recorders & DAQs (Data acquisition devices)

This is just a small selection of the options that are available for recording data from Carbolite Gero products. If you require advice, please contact Carbolite Gero for further information. **NOTE:** Please confirm with Carbolite Gero whether the chart recorder required can be fitted within the standard product case; in some instances it may require mounting in a separate case.

Eurotherm nanodac™ DAQ recorder only

In this configuration the nanodac™ can be used in combination with a conventional controller as a paperless chart recorder. Data is continuously logged into either CSV (comma separated variable) or secure UHH (Eurotherm Hydra History) files. Data can be archived onto a USB flash drive or via Ethernet to a networked server. Up to 4 channels can be recorded, with up to 14 virtual channels that can be set to record trends, alarms, communications, or mathematical functions such as totals or averages. Logged files can be opened and displayed on a PC, in chart form, using Eurotherm Review Lite software.

Always confirm with Carbolite Gero that your preferred data recorder can be fitted within the standard furnace case, alternatively a stand-alone cabinet may be required.

The following software options are available for use with the 6100 A, 6100 XIO and 6180 series data recorders for the 6100 series (these options are not compatible with the 6100 E model):

- Batching
- Grouping
- Screen Builder
- Bridge Software

Model	Function	Channels	Display screen	On-board memory for history (Mb)	USB ports	Serial ports
nanodac	PID control & record	4	3.5" TFT & software allocated keys	50	1	0
6100E	record analogue input	3 or 6	5.5" VGA touchscreen	8	1	0
6100A	record analogue input	6, 12 or 18	5.5" VGA touchscreen	32 or 96	up to 3	up to 2
6180A	record analogue input	6, 12, 18, 24, 30, 36, 42 or 48	12.1" XGA touchscreen	96	up to 3	up to 2
6100XIO	record digital comms input	128 virtual channels	5.5" VGA touchscreen	96	1	2
6180XIO	record digital comms input	128 virtual channels	12.1" XGA touchscreen	96	1	2
6180 AeroDAQ	record analogue input	6, 12, 18, 24, 30, 36, 42 or 48	12.1" XGA touchscreen	96	3	2

6100 & 6180 series digital data acquisition, recording & display

A series of digital data acquisition recorders which can function as stand-alone paperless recorders or with more advanced models can be integrated into computer networks. All have the capability to archive data via USB flash memory devices or onto a networked server using Ethernet FTP or Modbus TCP (although the 6100E is Slave configuration only). 6100 series data recorders have a 5.5" TFT touch screen interface whilst the 6180 series data recorders have a 12.1" TFT touch screen interface.



The 6100 XIO and 6180 XIO data recorders record digital data and so must be used with controllers that are equipped with digital communications. This overcomes potential issues from the attenuation of analogue signals over distance. The 6180 AeroDAQ is a recorder configuration that has been optimised for AMS2750E (Nadcap) applications and includes thermocouple monitoring.



iTools software

A versatile suite of software that allows Carbolite Gero products that have been fitted with appropriate digital communications hardware to be set-up, recorded and monitored from a PC. The supplied licence is for a single PC to communicate with one furnace using RS232 or with many furnaces using RS485. **NOTE:** The 301 controller is not compatible with RS485 communications.

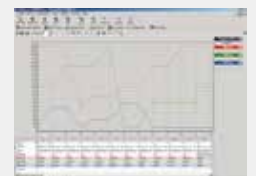

Work Tube Selection Guide

The material, length and diameter of the work tube required for use with each furnace differs. The appropriate material as well as correctly sized work tube for each furnace can be selected from the tables below. Work tube length depends on whether the furnace will be used to work in air or with modified atmosphere/vacuum.

Tube material	Physical & chemical properties			Maximum temperatures [°C]		
				in air		under vacuum pressure
	Porous / Impervious	Resistance to thermal shock is partly dependent upon specific tube dimensions	Chemical resistance	Horizontal	Vertical	Horizontal and Vertical
Sillimanite (Al₂SiO₅)	Porous	Good	Good chemical resistance but porous	1500	1600	-
IAP (Impervious aluminous porcelain)	Impervious	Very good	Good chemical resistance against gases, with the exception of fluorine	1400	1500	1200
Mullite (3Al₂O₃·2SiO₂)	Impervious	Very good	Resistant to flux sulphurous or carbonaceous atmospheres	1500	1550	1350
RCA (Recrystallised alumina)	Impervious	Good	Highly resistant to chemical attack, with the exception of fluorine	1800	1900	1500 (Ø 75 mm) 1450 (Ø > 75 to 88 mm)
Quartz	Impervious	Excellent	Generally good but reactive with sodium & at upper temperature limit with metals, carbonates & halides	1100	1100	1050
APM (Advanced powder metallurgy - FeCrAl)	Impervious	Excellent	Resistant to oxidation, carburization & sulphidation	1300	1350	1200
NiCr alloy (Inconel)	Impervious	Excellent	Good high temperature oxidation resistance combined with good resistance in carburising and chloride containing environments	1100	1100	750
High temperature stainless steel 1.4841 (314)	Impervious	Excellent	Good oxidation resistance	1100	1100	600

i Please note:

- Metal work tubes are unsuitable for use in wire wound tube furnaces due to high electrical conductivity
- Long unsupported horizontal work tubes will bend at high temperatures

MTF – CTF – TZF

The furnaces are constructed *with* an integral ceramic tube onto which the heating element is wound. An inner "work tube" is an option to protect the integral work tube when heating in air and is essential when gas tight or vacuum tight seals are to be added. The inner "work tube" lengths are as follows:

Model	Inner work tube for use in air			Inner work tube for use with modified atmosphere or vacuum		
	Length [mm]	Inner diameter [mm]	Outer diameter [mm]	Length [mm]	Inner diameter [mm]	Outer diameter [mm]
MTF 12/38/250	300	25	32	600	25	32
MTF 12/38/400	450	25	32	750	25	32
MTF 12/38/850	900	25	32	1200	25	32
CTF 12/65/550	600	50	60	900	50	60
CTF 12/75/700	750	60	70	1050	60	70
CTF 12/100/900	950	80	95	1200	80	95
TZF 12/38/400	450	25	32	750	25	32
TZF 12/38/850	900	25	32	1200	25	32
TZF 12/65/550	600	50	60	900	50	60
TZF 12/75/700	750	60	70	1050	60	70
TZF 12/100/900	950	80	95	1200	80	95

EHA, EHC, EVA, EVC, EST & EZS – EVT & EVZ

E range furnaces are constructed *without* an integral ceramic tube as the heating elements are vacuum formed into the insulation. An inner "work tube" must always be used whether heating in air or to allow gas tight or vacuum tight seals to be added. The inner "work tube" lengths are as follows:

Model	Inner work tube length for use in air (= heated length + 150 mm)		Inner work tube length for use with modified atmosphere or vacuum (= heated length + 450 mm)	
	Length [mm]	Max. outer diameter [mm]	Length [mm]	Max. outer diameter [mm]
EHA, EHC, EVA, EVC, EST & EZS				
E / 150	300	60	600	60
E / 300	450	60	750	60
E / 450	600	60	900	60
E / 600	750	60	1050	60
Model	(= heated length + 450 mm)		(= heated length + 450 mm)	
EVT & EVZ				
E / 150	600	60	600	60
E / 300	750	60	750	60
E / 450	900	60	900	60
E / 600	1050	60	1050	60

STF & TZF – VST

The tube furnaces are constructed *without* an integral ceramic tube. An inner "work tube" must always be supplied, to put the sample inside, whether heating in air or to allow gas tight or vacuum tight seals to be added. The inner "work tube" lengths are as follows:

Model	Inner work tube length for use in air		Inner work tube length for use with modified atmosphere or vacuum	
	Length [mm]	Max. outer diameter [mm]	Length [mm]	Max. outer diameter [mm]
STF 15/180	600	60	900	60
STF 15/450	900	90	1200	90
STF 15/610	1200	90	1500	90
STF 16/180	600	60	900	60
STF 16/450	900	90	1200	90
STF 16/610	1200	90	1500	90
TZF 15/610	1200	90	1500	90
TZF 16/610	1200	90	1500	90

HST & HZS – VST & TVS

Split tube furnaces are constructed *without* an integral ceramic tube as the heating elements are vacuum formed into the insulation. An inner "work tube" must always be supplied, to put the sample inside, whether heating in air or to allow gas tight or vacuum tight seals to be added. The inner "work tube" lengths are as follows:

Model	Inner work tube length for use in air (= heated length + 150 mm)*		Inner work tube length for use with modified atmosphere or vacuum (= heated length + 450 mm)	
	Length [mm]	Max. outer diameter [mm]	Length [mm]	Max. outer diameter [mm]
HST 12/200	350	110	650	110
HST 12/300	450	110	750	110
HST 12/400	550	110	850	110
HST 12/450	600	110	900	110
HST 12/600	750	110	1050	110
HST 12/900	1050	110	1350	110
HZS 12/600	750	110	1050	110
HZS 12/900	1050	110	1350	110

Model	(= heated length + 350 mm)		(= heated length + 450 mm)	
	Length [mm]	Max. outer diameter [mm]	Length [mm]	Max. outer diameter [mm]
VST 12/200	550	110	650	110
VST 12/300	650	110	750	110
VST 12/400	750	110	850	110
VST 12/450	800	110	900	110
VST 12/600	950	110	1050	110
VST 12/900	1250	110	1350	110
TVS 12/600	950	110	1050	110
TVS 12/900	1250	110	1350	110

GHA, GHC, GVA & GVC

G range furnaces are constructed *without* an integral ceramic tube as the heating elements are vacuum formed into the insulation. An inner "work tube" must always be used whether heating in air or to allow gas tight or vacuum tight seals to be added. The inner "work tube" lengths are as follows:

Model	Inner work tube length for use in air (= heated length + 200 mm)		Inner work tube length for use with modified atmosphere or vacuum (= heated length + 600 mm)	
	Length [mm]	Max. outer diameter [mm]	Length [mm]	Max. outer diameter [mm]
GHA, GHC, GVA & GVC				
G / 300	500	170	900	170
G / 450	650	170	1050	170
G / 600	800	170	1200	170
G / 750	950	170	1350	170
G / 900	1100	170	1500	170
G / 1050	1250	170	1650	170
G / 1200	1400	170	1800	170

FHA & FHC – FST & FZS – HTRH & HTRH-3 – HTRV & HTRV-A

The tube furnaces are constructed without an integral ceramic tube. An inner "work tube" must always be supplied, to put the sample inside, whether heating in air or to allow gas tight or vacuum tight seals to be added. The ** marked work tube diameters are only available for short work tubes for use in air. Long work tubes for use with modified atmosphere or vacuum are limited to a maximum diameter of 100 mm:

Model	Heated length [mm]	work tube length [mm]		Max. outer diameter [mm]
		in air	with modified atmosphere or vacuum	
FHA/FHC	200	390	925	80
FHA/FHC	500	690	1225	110
FHA/FHC	750	940	1475	110
FHA/FHC	1000	1190	1725	100
FHA/FHC	1250	1440	1925	110
FST/FZS	200	450	985	40
FST/FZS	500	670	1205	100
FST/FZS	1000	1190	1725	150
HTRH	100	380	915	40
HTRH	150	440	975	100
HTRH	250	530	1065	40
HTRH	300	580	1115	200**
HTRH	500	780	1275	40
HTRH	600	880	1415	200**
HTRH-3	600	880	1415	200**
HTRV	100	355	890	70
HTRV	250	505	1040	200**
HTRV	500	755	1290	200**
HTRV-A	120	470	910	70
HTRV-A	250	600	1040	70
HTRV-A	500	850	1290	70

i Please note:

*For HST and HZS models, fitted with 'L' stand, for use in air work tube length required is the same as VST models

Work tube package for inert, vacuum and for hydrogen atmosphere

Work tube packages are listed in the optional accessories section of each tube furnace, with the intention of providing a 'quick ordering' system for combining the accessories required for the specified application. Each package comprises a work tube of the specified diameter with a pair of end seals and heat shields appropriate for the operating atmosphere. A 3 mm probe thermocouple is included in all work tube packages for furnaces up to 1200 °C, for connection to a separate display or recorder. Above 1200 °C one end seal will have a 10 mm thermocouple gland with blanking plug to suit a probe thermocouple which must be ordered separately.

The work tube material in the packages are:

- Where the furnace maximum temperature is 1200 °C, there is a choice of:
IAP up to 1200 °C, quartz up to 1100 °C
- RCA where the furnace maximum temperature is between 1400 °C and 1800 °C

Alternatives to these packages can be created by selecting appropriate individual components.

- 1) Clamp
- 2) Seal plate
- 3) 'O' ring seal
- 4) Seal sleeve
- 5) Clamp seal
- 6) End plate

NOTE: The acceptable tolerance of the work tube outside diameter is +1.5 mm to -1 mm

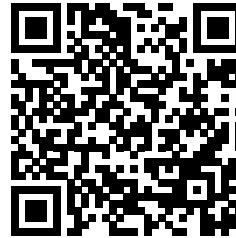

Watch our video for "Tube furnace accessories and work tube packages" (www.carbolite-gero.com/videos)

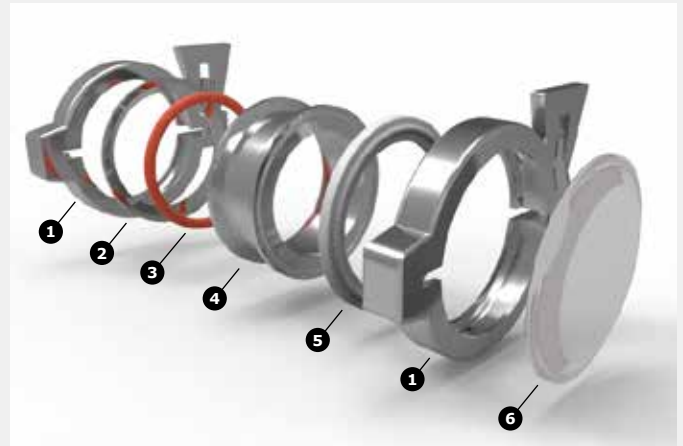

Work tube package for inert atmosphere

Tube furnace work tube package for inert atmosphere contains:

- 1) Extended length work tube
- 2) Insulation plugs suitable for horizontal or vertical use:
1 x standard
1 x thermocouple access slot
- 3) Work tube end seals:
1 x gas inlet/outlet pipe
1 x gas inlet/outlet pipe + thermocouple gland
- 4) Probe thermocouple access:
 - a: Up to 1200 °C:
Probe thermocouple gland complete with type N thermocouple
 - b: Above 1200 °C:
10 mm gland with PTFE seal and blanking plug to suit optional type R or B or 20/40 probe thermocouple assembly

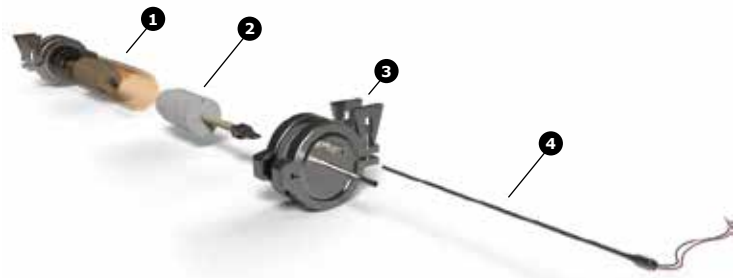

up to 1200 °C



Type D Insulation Plug

Work tube package for vacuum atmosphere

Available for work tube outer diameters 60, 70 & 86 mm.

Tube furnace work tube package for vacuum atmosphere is suitable for vacuum pressure to 10^{-2} mbar or 10^{-5} mbar depending on type of vacuum pump used (page 118) and contains:

- 1) Extended length work tube
- 2) Radiation shields suitable for horizontal or vertical use:
 - 1 x standard
 - 1 x thermocouple access slot
- 3) Work tube end seals:
 - 1 x NW16 vacuum flange + thermocouple gland
 - 2 x end plates: 1 x NW25 (compatible with low vacuum pump package); 1 x NW40 for 60 mm work tube outer diameter or 1 x ISO-K 63 for 70 & 86 mm work tube outer diameters (compatible with high vacuum pump package)
- 4) Probe thermocouple access:
 - a: Up to 1200 °C:
 - Probe thermocouple gland complete with type N thermocouple
 - b: Above 1200 °C:
 - 10 mm gland with PTFE seal and blanking plug to suit optional type R or B or 20/40 probe thermocouple assembly

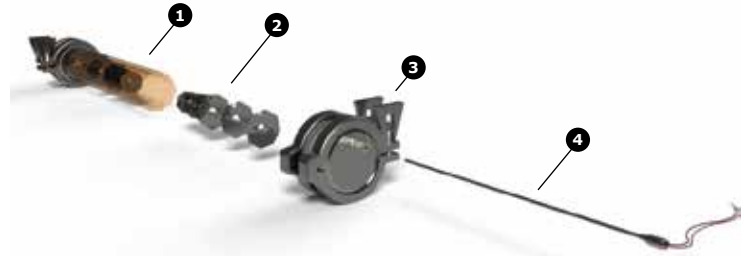

NW vacuum flange



Radiation Shield with Ceramic Discs



up to 1200 °C



Radiation Shield with Metal Discs

Work tube package for hydrogen atmosphere

Tube furnace work tube package for hydrogen atmosphere contains:

- 1) Extended length work tube
- 2) Insulation plugs suitable for horizontal or vertical use
 - 1 x standard
 - 1 x thermocouple access slot
- 3) Work tube end seals:
 - 1 x gas safety inlet fitting
 - 1 x gas safety outlet + thermocouple gland
- 4) Probe thermocouple access:
 - a: Up to 1200 °C: Probe thermocouple gland complete with type N thermocouple
 - b: Above 1200 °C: 10 mm gland with PTFE seal and blanking plug to suit optional type R or B or 20/40 probe thermocouple assembly

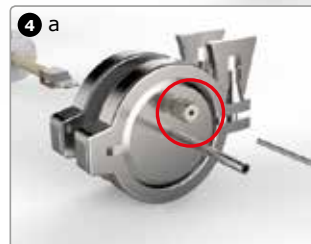
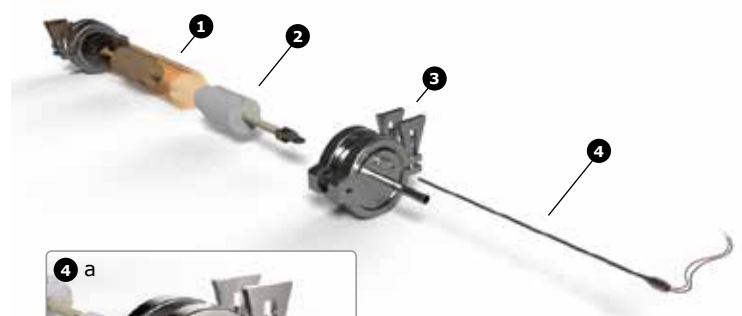

up to 1200 °C

NOTE: For hydrogen atmosphere a gas safety system **MUST** be used (see page 120).

To ensure the correct accessories are supplied, please specify the furnace model (horizontal or vertical use), work tube dimensions (inner diameter, outer diameter and length) and operating temperature.

Ceramic insulation plugs

Ceramic insulation plugs are designed to reduce heat loss from tube ends and improve temperature uniformity. They are particularly helpful for vertical tubes and tubes with diameters greater than 25 mm. Different insulation plugs are supplied for use with standard length work tubes (for use in air) and extended length work tubes (for use with modified atmosphere and vacuum). In vertical work tubes, insulation plug supports are required unless used with work tube end seals (see below). Type D insulation plugs include metallic hangers which allow vertical use and a groove for thermocouple access. The insulation plugs supplied will be appropriate for the furnace and application.



Type C insulation plug for use in air



Type D insulation plug for use in air or with modified atmosphere

Radiation shields

In extended work tubes radiation shields can be used as an alternative to insulation plugs. Specifically useful for dust free applications and with vacuum levels lower than 10^{-3} mbar. Up to a maximum operating temperature of 1200 °C the shields are constructed from metal, and above this temperature from ceramic. In vertical work tubes, radiation shield supports are required unless used with work tube end seals (see below). Radiation shields include metallic hangers which allow vertical use and a groove for thermocouple access. The shields supplied will be appropriate for the furnace and application.

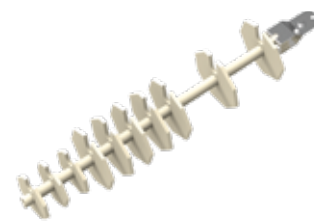

Ceramic radiation shield

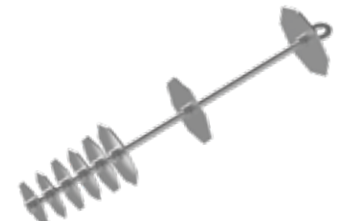

Metal radiation shield

Work tube end seals

Work tube end seals are required to contain a modified atmosphere and for working with vacuum; vacuum levels of 10^{-6} mbar are possible. These end seals are manufactured from stainless steel and are for use with extended work tubes only. They are available to fit work tubes with the following outside diameters: 32, 46, 60, 70, 86, 100, 111, 150, 165 and 200 mm. Other sizes are available at additional cost.

The following fittings are available for use with the end seals: blank seal, gas nozzle (inlet/outlet), vacuum flanges (NW16, NW25, NW40 or ISO-K 63) and thermocouple glands (ø1.5 mm, 3 mm and 10 mm). Where the end seal diameter is large enough, combinations of the above fittings are possible, e.g. gas inlet/out nozzle + thermocouple gland. The end seals are designed for use in combination with insulation plugs or radiation shields. Water cooled end seals are available on request. To accommodate the additional weight of end seals, tube supports are recommended (see below).



End seal with gas nozzle (inlet/outlet)



End seal with NW40 vacuum flange



End seal with gas nozzle and thermocouple gland (1.5 mm)

NOTE: The acceptable tolerance of the work tube outside diameter is +1.5 mm to -1 mm

Tube supports

Tube supports have two functions:

- to support extended work tubes
- to support extended work tubes with the additional weight of end seals



Optional hook and strap supports for STF & TZF 1500 & 1600°C tube furnaces

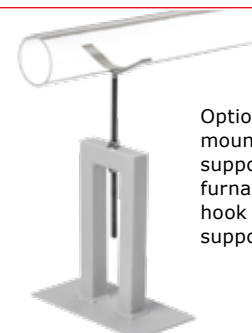

Optional bench mounted tube supports for furnaces not using hook and strap supports

Accessories for Operation under Vacuum and Process Gas

For applications under vacuum or process gas, a comprehensive range of accessories is available for the F range, HTRH and HTRV tube furnaces. Tightly sealed, high purity Al_2O_3 and Al_2O_3 / SiO_2 tube materials, water cooled stainless steel flanges, and gas supply equipment allow for thermal treatment under specified atmospheres. In such treatment processes, the gas flow can be controlled either manually, with use of a flow meter, or automatically, with the use of a mass flow controller. Complete vacuum pumping systems, rotary vane pumps, turbomolecular pumps, data recording systems, and visualization software complete the product range.



Attachment housings can be secured to the furnace for convenient vacuum / protective gas operation. It is possible to fit up to two gas supply stations to these housings.



Upon request, tube furnaces of the F range, HTRH and HTRV can be supplied with a robustly welded frame with or without castors and control cabinet.



As some furnaces can be used horizontally as well as vertically, an extra stand is available that is specifically designed to guarantee a safe working environment in any position.



Vacuum pumps or complete pumping systems with the appropriate measuring technology.



The furnace types F range, HTRH and HTRV can be provided with protective gas equipment or vacuum/protective gas equipment.



Equipment flanges can be furnished with fast clamping seals.



Water cooled stainless steel flange



Radiation protection packaging flange

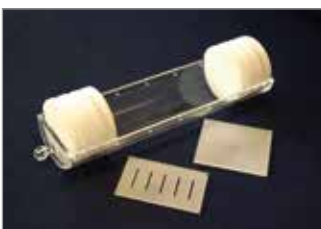

In response to customer demand, sample carriers for wafers or sample attachments of various materials are available.



For loading samples, sample boats and crucibles are available in various sizes and materials.



A comprehensively fitted, protective gas supply on a mounting plate or as an installation component are designed for laboratory customers.

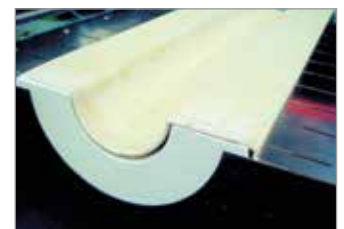

For split tube furnaces we offer robustly shaped ceramic panels to protect the heating elements and for sample holding.

Carbolite Gero offers vacuum pumps or complete pumping systems with the appropriate vacuum measuring technology.

A vacuum pump package consists of vacuum pump, flowmeter for inert gas, vacuum gauge, vacuum tight valve, bypass for fast purging, gas outlet valve and safety overpressure valve. The appropriate vacuum pump package must be selected to ensure compatibility between the height of the furnace work tube and the vacuum pump. Combining a vacuum pump package with a work tube vacuum package (page 114) offers a complete solution for horizontal tube furnaces. Please contact Carbolite Gero for assistance.

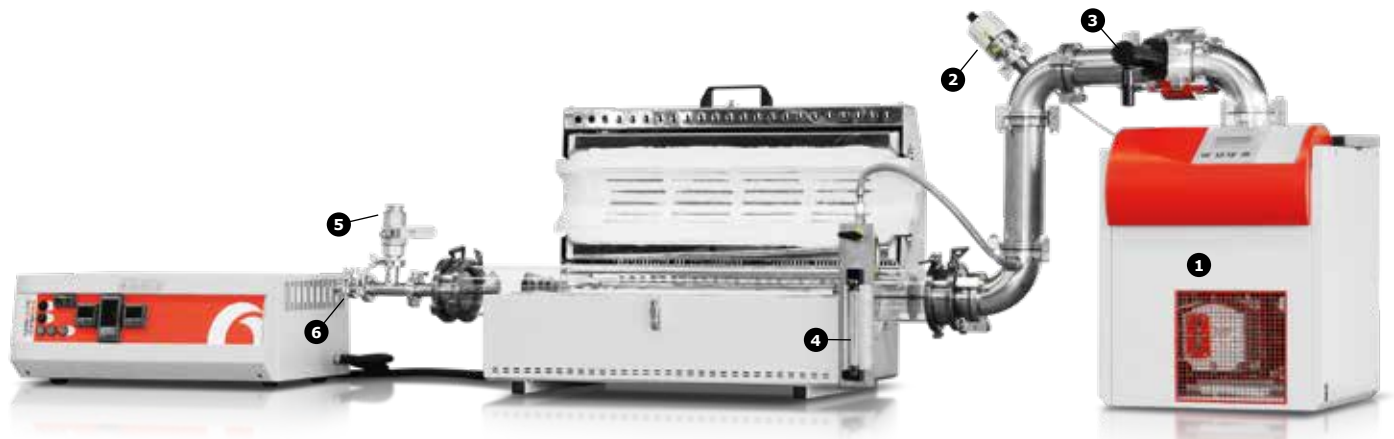

Example of the turbo pump option for tube furnaces - here with an HYS 12/600 furnace with 3508 main controller and over-temperature protection.

In a cold, clean, dry and empty furnace the rotary vane pump option is able to reach a vacuum level of 1×10^{-2} mbars, the turbo pump option reaches under the same conditions 1×10^{-5} mbars.

The rotary vane pump is a pre vacuum pump and is the most frequently used pump. The pump is used for direct evacuation of atmospheric pressure with a rotating speed of approximately 1,500 turns per minute via a radial, movable plug. The vacuum chamber of the pump is greased with oil.

Standard features

Rotary vane pump package:

- Double stage rotary vane pump with a pumping rate of 4 m³/h
- Pirani gauge
- Vacuum tight valve
- Choice of flowmeter for either nitrogen or argon
- Bypass for fast purging
- Gas outlet valve
- Safety overpressure valve

Turbo pump package:

- 1) Turbo pump with a pumping rate of 65 l/s
- Rotary vane pump as pre pump
- 2) Full range vacuum gauge
- 3) Vacuum tight valve
- 4) Choice of flowmeter for either nitrogen or argon
- Bypass for fast purging
- 5) Gas outlet valve
- 6) Safety overpressure valve

The turbomolecular pump consists of stators between several high speed rotors. The rotational speed is about 90,000 revolutions per minute. At these speeds, the rotor is now in the range of the particle velocity enabling gas to be pushed through the pump. When combined with a pre-vacuum pump, the achievable vacuum level is in the high vacuum range or better. Turbomolecular pumps are the most convenient and frequently used pumps for high and ultra-high vacuum operation. Very high atmospheric purity of the furnace chamber is achieved as the pump easily removes heavy, slow particles, such as hydrocarbons, and maintains the high speeds needed to evacuate light, fast moving particles.

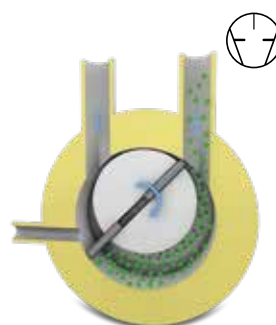

Rotary vane pump

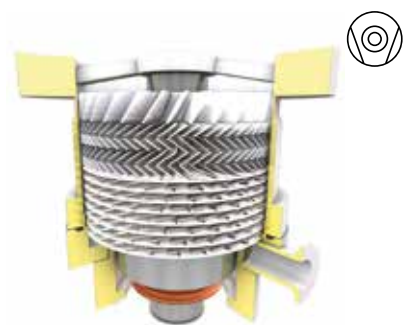

Turbomolecular pump

Atmosphere retorts

A retort can be used for various heat treating processes requiring a controlled inert or reactive atmosphere, e.g. to prevent oxidation or to enhance surface hardness. The A105 retort, which incorporates a silicone rubber seal, can achieve lower oxygen levels than the A107 retort which uses a sand seal. Manufactured in either NiCr alloy (Inconel) with a maximum operating temperature of 1100 °C or 314 grade stainless steel with a maximum operating temperature of 1050 °C.

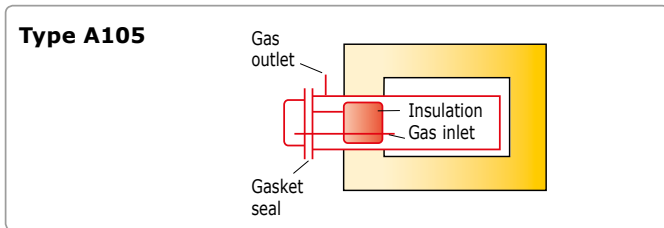

The A105 NiCr alloy (Inconel) retort is sealed by a removable front opening insulated door fitted with a silicone rubber seal. Gas inlet and outlet connections are easily accessible at the front. Oxygen levels down to 30 ppm are achievable. A105 retorts for CWF furnaces are fitted with a 3 mm thermocouple gland through the centre of the door. The retort and furnace must be ordered together as the furnace is modified to allow it to be used with, and without, the retort.

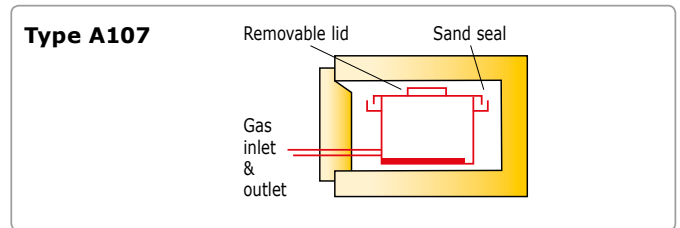

The A107 NiCr alloy (Inconel) retort with a shallow removable lid locates into a sand seal on top of a deep base. Can be used for annealing and pack carburising. Front mounted gas inlet/outlet connections extend through slots in the furnace door.

The retort and furnace must be ordered together as the furnace is modified to allow it to be used with, and without, the retort.



Technical data

A105 internal dimensions

CGH Model	Height h/H [mm]	Width W [mm]	Depth [mm]	Door type
CGH CWF __/13	135/150	150	275	pull out
CGH CWF __/23	170/185	195	350	pull out
CGH CWF 12/36	180/200	270	400	pull out
CGH CWF 12/65	200/225	335	540	pull out

GPCMA retort internal dimension

GPCMA/37	205/230	337	538
GPCMA/56	238/295	400	665
GPCMA/117	278/345	500	815
GPCMA/174	428/495	500	815
GPCMA/208	428/495	500	965
GPCMA/245	500/574	600	815

NEW

A107 internal dimensions

CGH Model	Height h/H [mm]	Width W [mm]	Depth [mm]	Lid type
CGH CWF __/13	130	140	255	lift off
CGH CWF __/23	155	160	330	lift off
CGH CWF 12/36	160	205	375	lift off
CGH CWF 12/65	200	250	500	lift off

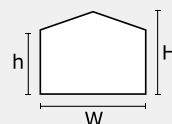

The following modified atmosphere options are available (must be specified at the time of order).

Inert gas inlet

A 6 mm hose connection is fitted to the product chamber via a tube to create a modified atmosphere. Suitable for the introduction of inert gas or oxygen. Flow rate may be controlled by flow meters – please see below.

NOTE: The introduction of gases may alter heating characteristics and/or performance characteristics of furnace elements, please contact Carbolite Gero for advice.

Gas flow meters

Used to control the flow rate of a gas into the chamber, work tube or retort. A number of flow meters can be fitted for different gases. Suitable for use with argon, carbon dioxide, nitrogen and oxygen – for other gases please enquire. These are fitted to the product on an additional bracket.



Entry ports

Access and viewing ports

A 25 mm diameter hole is positioned in the furnace door and is either fitted with a pivoted stainless steel cover or a permanent quartz window.

Secondary thermocouple

An additional thermocouple is built into the product and connected to a thermocouple socket which is externally mounted on the control panel to enable connection to temperature recorders or other external equipment.

Thermocouple calibration port (for chamber furnaces only)

An additional ceramic thermocouple sheath is installed adjacent to the control thermocouple. This allows the user to insert a reference thermocouple for checking and calibration of the furnace's controller / thermocouple. This is normally located in the rear of the chamber.

Solenoid valves

Electrically operated valve to control the gas flow into a chamber, work tube or retort. Manually activated by a panel mounted switch or automatically using a temperature programmer. A number of solenoid valves can be fitted for different gases; when used with a temperature programmer the gases can be switched on/off in different program segments (requires 3508 or nanodac™ controller).

Atmosphere control system (gas safety system)

This system is suitable for use with either tube furnaces using work tube end seals or chamber furnaces using A105 retorts. Housed in its own cabinet, the system is required where hydrogen gas is used. It provides greater safety and convenience in control of atmospheres containing more than 5% hydrogen and incorporates a nitrogen purge gas. The system allows hydrogen to enter a sealed work tube or retort once the temperature is greater than 800 °C. A monitored burn-off pilot flame ensures exit gases are fully burned. This system monitors the gas pressure, the burn-off flame and the furnace temperature. Failure of any of these results in a safety nitrogen purge. Systems with mass flow control are also available.

NOTE: Hydrogen can only be admitted once the furnace temperature is **ABOVE** 800 °C.



CWF 12/36 with A105 Inconel retort and gas safety system

Tube furnaces with full safety equipment for special gas atmospheres e. g. hydrogen

In this example the hydrogen tube furnace system is based on the HTRH 16/100/600 tube furnace. It is designed to meet all required regulations for the safe handling of hydrogen gas. Other gases such as chlorine, ammonia, methane or other hydrocarbon gases, CO, CO₂ and H₂S are available as well.

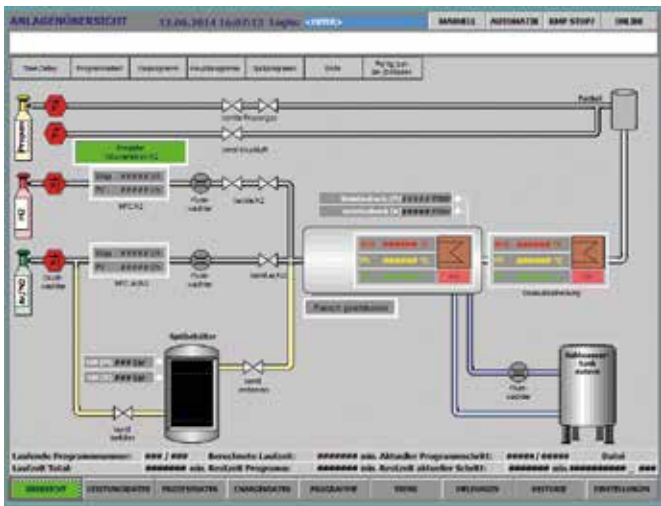

A touch panel interface is used for automated operation. All valves, temperatures, gas flows, etc. can be switched on and off manually or automatically by a predetermined program.



The purging tank is filled with inert nitrogen at a pressure of 8 bar. The purging tank is a required safety option when working with pure hydrogen or other dangerous gases. In case of an emergency this tank provides enough inert gas for purging the whole furnace multiple times to ensure that no dangerous gas remains in the furnace.

HTRH 16/100/600: Hydrogen tube furnace with a heated length of 600 mm up to 1600°C. Operation under pure hydrogen is possible. All necessary safety provisions are implemented.

- 1) Hydrogen sensor
- 2) Afterburner
- 3) Heated gas outlet system
- 4) Touchpanel for automatic operation



The table below shows the standard power supply for products requiring an electrical supply more than 16 A single phase. Products not listed here can be used on a 220-204V single phase 16 A supply. Other voltages on request. Please mention your preferred voltage in your enquiry. Upgrade prices may apply.

	Model	Volt	Phase	Ampere per phase
CGH	AAF /18 litre	220-240	single phase	30
CGH	AAF /18 litre	220-240	3 phase delta	18.5
CGH	AAF /18 litre	380-415	3 phase + N	10.5
CGH	AAF 11/7	240	single phase	17
CGH	AAF 11/7	220-230	single phase	16
CGH	AAF 11/7	380-415	2 phase + N	8.2
CGH	AAF /32 litre	220-240	single phase	44
CGH	AAF /32 litre	220-240	3 phase delta	26
CGH	AAF /32 litre	380-415	3 phase + N	15
CGH	AAF-BAL /17	220-240	single phase	30
CGH	AAF-BAL /17	220-240	3 phase delta	18.5
CGH	AAF-BAL /17	380-415	3 phase + N	10.5
CGH	ABA 7/35	220-240	single phase	40
CGH	ABA 7/35	220-240	3 phase delta	24
CGH	ABA 7/35	380-415	3 phase + N	15
CGH	ABF 8/28	220-240	single phase	40
CGH	ABF 8/28	220-240	3 phase delta	24
CGH	ABF 8/28	380-415	3 phase + N	15
CGN	AZ 13/32/360	380-415	3 phase + N	max. 16A
CGN	AZ 13/32/360	other voltages and phases on request		
CGN	AZ 13/50/430	380-415	3 phase + N	max. 16A
CGN	AZ 13/50/430	other voltages and phases on request		
CGN	AZ 13/80/810	380-415	3 phase + N	max. 16A
CGN	AZ 13/80/810	other voltages and phases on request		
CGN	AZ 13/110/1000	380-415	3 phase + N	max. 32A
CGN	AZ 13/110/1000	other voltages and phases on request		
CGH	BLF __/21	380-415	3 phase + N	20
CGH	BLF 16/3	380-415	3 phase + N	16
CGH	BLF 16/3	220-240	single phase	48
CGH	BLF 17/3	200-208	single phase	29
CGH	BLF 17/3	220-240	single phase	28
CGH	BLF 17/3	380-415	2 phase + N	16.5
CGH	BLF 17/8	208	single phase	49
CGH	BLF 17/8	208	3 phase delta	29
CGH	BLF 17/8	220-240	single phase	46
CGH	BLF 17/8	220-240	3 phase delta	27
CGH	BLF 17/8	380-415	3 phase + N	15.5
CGH	BLF 18/3	208	single phase	26
CGH	BLF 18/3	220-240	single phase	25
CGH	BLF 18/8	208	3 phase delta	29
CGH	BLF 18/8	220-240	3 phase delta	27
CGH	BLF 18/8	380-415	3 phase + N	15.5
CGH	CAF G5	220-240	single phase	49
CGH	CAF G5	380-415	2 phase + N	25
CGH	CDHT	380-415	3 phase + N	13
CGH	CDLT	380-415	3 phase + N	6.8
CGH	CF 24	200	single phase	87
CGH	CF 24	440	3 phase no N	30
CGH	CF 24	200-240	3 phase delta	50
CGH	CF 24	380-415	3 phase + N	28
CGH	CF 60	440	3 phase + N	59
CGH	CF 60	200-240	3 phase delta	103
CGH	CF 60	380-415	3 phase + N	59

	Model	Volt	Phase	Ampere per phase
CGH	CF15	200-240	single phase	68
CGH	CF15	200-240	3 phase delta	40
CGH	CF15	380-415	3 phase + N	23
CGH	CR /330 litre	220-240	single phase	19.5
CGH	CR /330 litre	380-415	3 phase + N	8.9
CGH	CR /450 litre	220-240	3 phase delta	15.5
CGH	CR /450 litre	380-415	3 phase + N	8.9
CGH	CR above 450 please enquire			
CGH	CTF 12/100/900	200-240	single phase	21
CGH	CTF 12/100/900	220-240	single phase	21
CGH	CTF 12/100/900	380-415	2 phase + N	10.5
CGH	CWF /13 litre	220-240	single phase	13
CGH	CWF /13 litre	380-415	2 phase + N	7.1
CGH	CWF /23 litre	110-120	single phase	60
CGH	CWF /23 litre	200-208	single phase	36
CGH	CWF /23 litre	200-208	3 phase delta	22
CGH	CWF /23 litre	220-240	single phase	30
CGH	CWF /23 litre	220-240	3 phase delta	18.5
CGH	CWF /23 litre	380-415	3 phase + N	10.5
CGH	CWF /23 litre	380-415	3 phase no N	11
CGH	CWF /23 litre	440-480	3 phase no N	10.5
CGH	CWF /36 litre	220-240	single phase	44
CGH	CWF /36 litre	220-240	3 phase delta	26
CGH	CWF /36 litre	380-415	3 phase + N	15
CGH	CWF /65 litre	220-240	single phase	63
CGH	CWF /65 litre	220-240	3 phase delta	37
CGH	CWF /65 litre	380-415	3 phase + N	21
CGH	CWF-B /13 litre	220-240	single phase	13
CGH	CWF-B /13 litre	380-415	2 phase + N	7.1
CGH	CWF-BAL /21	220-240	single phase	30
CGH	CWF-BAL /21	220-240	3 phase delta	18.5
CGH	CWF-BAL /21	380-415	3 phase + N	10.5
CGH	ELF 11/23	200-240	single phase	25
CGH	ELF 11/23	380-415	2 phase + N	12.5
CGN	FHA 13/50/750	380-415	3 phase + N	max. 16A
CGN	FHA 13/50/750	other voltages and phases on request		
CGN	FHA 13/80/500	380-415	3 phase + N	max. 16A
CGN	FHA 13/80/500	other voltages and phases on request		
CGN	FHA 13/80/750	380-415	3 phase + N	max. 32A
CGN	FHA 13/80/750	other voltages and phases on request		
CGN	FHA 13/80/1000	380-415	3 phase + N	max. 32A
CGN	FHA 13/80/1000	other voltages and phases on request		
CGN	FHA 13/110/500	380-415	3 phase + N	max. 32A
CGN	FHA 13/110/500	other voltages and phases on request		
CGN	FHA 13/110/750	380-415	3 phase + N	max. 32A
CGN	FHA 13/110/750	other voltages and phases on request		
CGN	FHA 13/110/1000	380-415	3 phase + N	max. 63A
CGN	FHA 13/110/1000	other voltages and phases on request		
CGN	FHA 13/110/1250	380-415	3 phase + N	max. 63A
CGN	FHA 13/110/1250	other voltages and phases on request		
CGN	FHC 13/50/750	380-415	3 phase + N	max. 16A
CGN	FHC 13/50/750	other voltages and phases on request		
CGN	FHC 13/80/500	380-415	3 phase + N	max. 16A

	Model	Volt	Phase	Ampere per phase
CGN	FHC 13/80/500	other voltages and phases on request		
CGN	FHC 13/80/750	380-415	3 phase + N	max. 32A
CGN	FHC 13/80/750	other voltages and phases on request		
CGN	FHC 13/80/1000	380-415	3 phase + N	max. 32A
CGN	FHC 13/80/1000	other voltages and phases on request		
CGN	FHC 13/110/500	380-415	3 phase + N	max. 32A
CGN	FHC 13/110/500	other voltages and phases on request		
CGN	FHC 13/110/750	380-415	3 phase + N	max. 32A
CGN	FHC 13/110/750	other voltages and phases on request		
CGN	FHC 13/110/1000	380-415	3 phase + N	max. 63A
CGN	FHC 13/110/1000	other voltages and phases on request		
CGN	FHC 13/110/1250	380-415	3 phase + N	max. 63A
CGN	FHC 13/110/1250	other voltages and phases on request		
CGN	FST 13/100/500	380-415	3 phase + N	max. 16A
CGN	FST 13/100/500	other voltages and phases on request		
CGN	FST 13/100/1000	380-415	3 phase + N	max. 32A
CGN	FST 13/100/1000	other voltages and phases on request		
CGN	FST 13/150/1000	380-415	3 phase + N	max. 63A
CGN	FST 13/150/1000	other voltages and phases on request		
CGN	FZS 13/100/500	380-415	3 phase + N	max. 16A
CGN	FZS 13/100/500	other voltages and phases on request		
CGN	FZS 13/100/1000	380-415	3 phase + N	max. 32A
CGN	FZS 13/100/1000	other voltages and phases on request		
CGN	FZS 13/150/1000	380-415	3 phase + N	max. 63A
CGN	FZS 13/150/1000	other voltages and phases on request		
CGH	GHA, GHC, GVA & GVC 12/1050	220-240	single phase	30
CGH	GHA, GHC, GVA & GVC 12/1050	220-240	3 phase delta	18
CGH	GHA, GHC, GVA & GVC 12/1050	380-415	3 phase + N	11.5
CGH	GHA, GHC, GVA & GVC 12/1200	220-240	single phase	34
CGH	GHA, GHC, GVA & GVC 12/1200	220-240	3 phase delta	19.5
CGH	GHA, GHC, GVA & GVC 12/1200	380-415	3 phase + N	11.5
CGH	GHA, GHC, GVA & GVC 12/600	220-240	single phase	19
CGH	GHA, GHC, GVA & GVC 12/600	220-240	3 phase delta	11.5
CGH	GHA, GHC, GVA & GVC 12/600	380-415	3 phase + N	7.5
CGH	GHA, GHC, GVA & GVC 12/750	220-240	single phase	23
CGH	GHA, GHC, GVA & GVC 12/750	220-240	3 phase delta	15
CGH	GHA, GHC, GVA & GVC 12/750	380-415	3 phase + N	9.4
CGH	GHA, GHC, GVA & GVC 12/900	220-240	single phase	27
CGH	GHA, GHC, GVA & GVC 12/900	220-240	3 phase delta	16.5

	Model	Volt	Phase	Ampere per phase
CGH	GHA, GHC, GVA & GVC 12/900	380-415	3 phase + N	9.4
CGN	GLO models	please enquire		
CGH	GP330	220-240	single phase	19.5
CGH	GP330	220-240	3 phase delta	12
CGH	GP330	380-415	3 phase + N	7
CGH	GP450	220-240	single phase	26
CGH	GP450	220-240	3 phase delta	15
CGH	GP450	380-415	3 phase + N	12.5
CGH	GPC __/131B	200-240	3 phase delta	80
CGH	GPC __/131B	380-415	3 phase + N	26
CGH	GPC __/200B	other voltages and phases on request		
CGH	GPC __/200B	380-415	3 phase + N	50
CGH	GPC __/300B	200-240	3 phase delta	125
CGH	GPC __/300B	380-415	3 phase + N	63
CGH	GPC __/350B	200-240	3 phase delta	125
CGH	GPC __/350B	380-415	3 phase + N	80
CGH	GPCMA/ __ please enquire			
CGN	HB	please enquire		
CGH	HRF 7/112	220-240	3 phase delta	44
CGH	HRF 7/112	380-415	3 phase + N	26
CGH	HRF 7/324	380-415	3 phase + N	34
CGH	HRF 7/45	220-240	single phase	26
CGH	HRF 7/45	220-240	3 phase delta	15.5
CGH	HRF 7/45	380-415	3 phase + N	9
CGH	HST 12/900	200-240	3 phase delta	15
CGH	HST 12/900	220-240	single phase	22
CGH	HST 12/900	380-415	3 phase + N	8.4
CGH	HT, HTCR, HTMA 5/220	220-240	single phase	19.5
CGH	HT, HTCR, HTMA 5/220	380-415	2 phase + N	10
CGH	HT, HTCR, HTMA 6/220	220-240	single phase	26
CGH	HT, HTCR, HTMA 6/220	220-240	3 phase delta	15
CGH	HT, HTCR, HTMA 6/220	380-415	3 phase + N	12.5
CGH	HT, HTCR, HTMA 6/95	220-240	single phase	19.5
CGH	HT, HTCR, HTMA 6/95	380-415	2 phase + N	10
CGH	HTMA 7/95	380-415	3 phase + N	25
CGH	HT, HTCR, HTMA above 220 litre please enquire			
CGH	HTF 17/10	220-240	single phase	28
CGH	HTF 17/10	380-415	2 phase + N	16
CGH	HTF 17/27	380-415	3 phase + N	max. 32A
CGH	HTF 17/27	other voltages on request		
CGH	HTF 18/27	380-415	3 phase + N	max. 32A
CGH	HTF 18/27	other voltages on request		
CGH	HTF 18/4	220-240	single phase	21
CGH	HTF 18/4	380-415	2 phase + N	16
CGH	HTF 18/8	220-240	single phase	30
CGH	HTF 18/8	380-415	2 phase + N	16
CGN	HTF __/64	380-415	3 phase + N	max. 63A
CGN	HTF __/64	other voltages and phases on request		
CGN	HTF __/128	380-415	3 phase + N	max. 125A
CGN	HTF __/128	other voltages and phases on request		
CGN	HTF __/165 - please enquire			
CGN	HTF __/250 - please enquire			

	Model	Volt	Phase	Ampere per phase
CGN	HTF __/332 – please enquire			
CGN	HTF __/514 – please enquire			
CGN	HTRH __/40/500	380-415	3 phase + N	max. 32A
CGN	HTRH __/40/500	other voltages and phases on request		
CGN	HTRH __/70/150	380-415	3 phase + N	max. 16A
CGN	HTRH __/70/150	other voltages and phases on request		
CGN	HTRH __/70/300	380-415	3 phase + N	max. 16A
CGN	HTRH __/70/300	other voltages and phases on request		
CGN	HTRH __/70/600	380-415	3 phase + N	max. 32A
CGN	HTRH __/70/600	other voltages and phases on request		
CGN	HTRH __/100/150	380-415	3 phase + N	max. 16A
CGN	HTRH __/100/150	other voltages and phases on request		
CGN	HTRH __/100/300	380-415	3 phase + N	max. 32A
CGN	HTRH __/100/300	other voltages and phases on request		
CGN	HTRH __/100/600	380-415	3 phase + N	max. 32A
CGN	HTRH __/100/600	other voltages and phases on request		
CGN	HTRH __/150/300	380-415	3 phase + N	max. 32A
CGN	HTRH __/150/300	other voltages and phases on request		
CGN	HTRH __/150/600	380-415	3 phase + N	max. 32A
CGN	HTRH __/150/600	other voltages and phases on request		
CGN	HTRH __/200/300	380-415	3 phase + N	max. 32A
CGN	HTRH __/200/300	other voltages and phases on request		
CGN	HTRH __/200/600	380-415	3 phase + N	max. 32A
CGN	HTRH __/200/600	other voltages and phases on request		
CGN	HTRH-3 __/70/600	380-415	3 phase + N	max. 32A
CGN	HTRH-3 __/70/600	other voltages and phases on request		
CGN	HTRH-3 __/100/600	380-415	3 phase + N	max. 32A
CGN	HTRH-3 __/100/600	other voltages and phases on request		
CGN	HTRH-3 __/150/600	380-415	3 phase + N	max. 32A
CGN	HTRH-3 __/150/600	other voltages and phases on request		
CGN	HTRV __/40/500	380-415	3 phase + N	max. 16A
CGN	HTRV __/40/500	other voltages and phases on request		
CGN	HTRV __/70/250	380-415	3 phase + N	max. 16A
CGN	HTRV __/70/250	other voltages and phases on request		
CGN	HTRV __/70/500	380-415	3 phase + N	max. 32A
CGN	HTRV __/70/500	other voltages and phases on request		
CGN	HTRV __/100/250	380-415	3 phase + N	max. 16A
CGN	HTRV __/100/250	other voltages and phases on request		
CGN	HTRV __/100/500	380-415	3 phase + N	max. 32A
CGN	HTRV __/100/500	other voltages and phases on request		
CGN	HTRV __/150/250	380-415	3 phase + N	max. 32A
CGN	HTRV __/150/250	other voltages and phases on request		
CGN	HTRV __/150/500	380-415	3 phase + N	max. 63A
CGN	HTRV __/150/500	other voltages and phases on request		
CGN	HTRV __/200/250	380-415	3 phase + N	max. 32A
CGN	HTRV __/200/250	other voltages and phases on request		
CGN	HTRV __/200/500	380-415	3 phase + N	max. 63A
CGN	HTRV __/200/500	other voltages and phases on request		
CGN	HTRV-A __/70/120	380-415	3 phase + N	max. 16A
CGN	HTRV-A __/70/120	other voltages and phases on request		
CGN	HTRV-A __/70/250	380-415	3 phase + N	max. 32A
CGN	HTRV-A __/70/250	other voltages and phases on request		
CGN	HTRV-A __/70/500	380-415	3 phase + N	max. 32A

	Model	Volt	Phase	Ampere per phase
CGN	HTRV-A __/70/500	other voltages and phases on request		
CGH	HZS 12/900	200-240	3 phase delta	15
CGH	HZS 12/900	220-240	single phase	22
CGH	HZS 12/900	380-415	3 phase + N	8.4
CGH	KST 12/200/600	200-208	single phase	38
CGH	KST 12/200/600	200-208	3 phase delta	22
CGH	KST 12/200/600	220-240	single phase	36
CGH	KST 12/200/600	220-240	3 phase delta	21
CGH	KST 12/200/600	380-415	3 phase + N	12
CGH	KZS 12/200/600	200-208	single phase	40
CGH	KZS 12/200/600	200-208	3 phase delta	23
CGH	KZS 12/200/600	220-240	single phase	36
CGH	KZS 12/200/600	220-240	3 phase delta	21
CGH	KZS 12/200/600	380-415	3 phase + N	12
CGH	KZS 12/200/1200	200-208	3 phase delta	42
CGH	KZS 12/200/1200	220-240	3 phase delta	39
CGH	KZS 12/200/1200	380-415	3 phase + N	21
CGH	KVT 12/200/600	200-208	single phase	40
CGH	KVT 12/200/600	200-208	3 phase delta	23
CGH	KVT 12/200/600	220-240	single phase	36
CGH	KVT 12/200/600	220-240	3 phase delta	21
CGH	KVT 12/200/600	380-415	3 phase + N	12
CGH	KVZ 12/200/600	200-208	single phase	40
CGH	KVZ 12/200/600	200-208	3 phase delta	23
CGH	KVZ 12/200/600	220-240	single phase	36
CGH	KVZ 12/200/600	220-240	3 phase delta	21
CGH	KVZ 12/200/600	380-415	3 phase + N	12
CGH	KZS 12/200/1200	200-208	3 phase delta	52
CGH	KZS 12/200/1200	220-240	3 phase delta	47
CGH	KZS 12/200/1200	380-415	3 phase + N	26
CGH	LCF – please enquire			
CGH	LGP – please enquire			
CGH	RHF 14/15	200-240	single phase	62
CGH	RHF 14/15	200-240	3 phase delta	38
CGH	RHF 14/15	380-415	3 phase + N	22
CGH	RHF 14/3	200-240	single phase	22
CGH	RHF 14/3	380-415	2 phase + N	15
CGH	RHF 14/35	200-240	3 phase delta	60
CGH	RHF 14/35	380-415	3 phase + N	35
CGH	RHF 14/35	440-480	3 phase no N	35
CGH	RHF 14/8	200-240	single phase	50
CGH	RHF 14/8	380-415	2 phase + N	25
CGH	RHF 15/15	200-240	single phase	75
CGH	RHF 15/15	200-240	3 phase delta	43
CGH	RHF 15/15	380-415	3 phase + N	25
CGH	RHF 15/3	200-240	single phase	36
CGH	RHF 15/3	380-415	2 phase + N	18
CGH	RHF 15/35	200-240	3 phase delta	60
CGH	RHF 15/35	380-415	3 phase + N	35
CGH	RHF 15/35	380-415	3 phase no N	35
CGH	RHF 15/35	440-480	3 phase no N	35
CGH	RHF 15/8	200-208	3 phase delta	38
CGH	RHF 15/8	200-240	single phase	50

	Model	Volt	Phase	Ampere per phase
CGH	RHF 15/8	200-240	3 phase delta	30
CGH	RHF 15/8	380-415	3 phase + N	17.5
CGH	RHF 15/8	380-415	3 phase no N	17.5
CGH	RHF 16/15	200-240	single phase	73
CGH	RHF 16/15	200-240	3 phase delta	42
CGH	RHF 16/15	380-415	3 phase + N	25
CGH	RHF 16/15	440-480	3 phase + N	25
CGH	RHF 16/3	200-240	single phase	36
CGH	RHF 16/3	200-240	3 phase delta	30
CGH	RHF 16/3	380-415	2 phase + N	18
CGH	RHF 16/35	200-240	3 phase delta	62
CGH	RHF 16/35	380-415	3 phase + N	40
CGH	RHF 16/35	380-415	3 phase no N	37
CGH	RHF 16/35	440-480	3 phase + N	40
CGH	RHF 16/8	200-208	3 phase delta	34
CGH	RHF 16/8	200-208	single phase	59
CGH	RHF 16/8	220-240	single phase	50
CGH	RHF 16/8	220-240	3 phase delta	29
CGH	RHF 16/8	380-415	3 phase + N	18
CGH	RHF 16/8	380-415	3 phase no N	18
CGH	RHF 16/8	440-480	3 phase + N	18
CGH	RHST 600	220 - 240	single phase	17
CGH	RHST 600	380 - 415	3 phase + N	5
CGH	RHST 600	200 - 240	3 phase delta	10
CGH	RHST 900	220 - 240	single phase	25
CGH	RHST 900	380 - 415	3 phase + N	8
CGH	RHST 900	200 - 240	3 phase delta	14
CGH	RHZS 600	220 - 240	single phase	17
CGH	RHZS 600	380 - 415	3 phase + N	5
CGH	RHZS 600	200 - 240	3 phase delta	10
CGH	RHZS 900	220 - 240	single phase	25
CGH	RHZS 900	380 - 415	3 phase + N	8
CGH	RHZS 900	200 - 240	3 phase delta	14
CGH	RWF /13 litre	220-240	single phase	22
CGH	RWF /13 litre	380-415	2 phase + N	11
CGH	RWF /23 litre	220-240	single phase	39
CGH	RWF /23 litre	220-240	3 phase delta	23
CGH	RWF /23 litre	380-415	3 phase + N	13
CGH	SBCF models – please enquire			
CGH	SCF – please enquire			
CGH	STF 15/180	110-120	single phase	24
CGH	STF 15/180	200-240	single phase	12
CGH	STF 15/450	208	3 phase + N	25
CGH	STF 15/450	200-240	single phase	39
CGH	STF 15/450	380-415	2 phase + N	19.5
CGH	STF 15/610	200-208	single phase	44
CGH	STF 15/610	200-240	3 phase delta	34
CGH	STF 15/610	220-240	single phase	32
CGH	STF 15/610	220-240	3 phase + N	19.5
CGH	STF 15/610	380-415	2 phase + N	19.5
CGH	STF 16/180	200-240	single phase	23
CGH	STF 16/450	200-240	single phase	47
CGH	STF 16/450	200-240	3 phase delta	39

	Model	Volt	Phase	Ampere per phase
CGH	STF 16/450	380-415	2 phase + N	24
CGH	STF 16/450	380-415	3 phase + N	21
CGH	STF 16/450	380-415	3 phase no N	21
CGH	STF 16/610	380	3 phase + N	25
CGH	STF 16/610	200-220	3 phase delta	43
CGH	STF 16/610	200-240	single phase	50
CGH	STF 16/610	230-240	3 phase delta	46
CGH	STF 16/610	380-415	2 phase + N	25
CGH	STF 16/610	400-415	3 phase + N	27
CGH	TVS 12/900	200-240	3 phase delta	15
CGH	TVS 12/900	220-240	single phase	22
CGH	TVS 12/900	380-415	3 phase + N	8.4
CGH	TZF 12/100/900	220-240	single phase	19.5
CGH	TZF 12/100/900	380-415	3 phase + N	8.4
CGH	TZF 15/450	220-240	single phase	43
CGH	TZF 15/450	220-240	3 phase delta	34
CGH	TZF 15/450	380-415	3 phase + N	20
CGH	TZF 15/610	200-240	single phase	60
CGH	TZF 15/610	220-240	3 phase delta	38
CGH	TZF 15/610	380-415	3 phase + N	22
CGH	TZF 16/450	220-240	single phase	53
CGH	TZF 16/450	220-240	3 phase delta	40
CGH	TZF 16/450	380-415	3 phase + N	23
CGH	TZF 16/610	220-240	single phase	62
CGH	TZF 16/610	220-240	3 phase delta	40
CGH	TZF 16/610	380-415	3 phase + N	25
CGH	VCF 12/100	220-240	single phase	69
CGH	VCF 12/100	220-240	3 phase delta	40
CGH	VCF 12/100	380-415	3 phase + N	23
CGH	VCF 12/23	220-240	single phase	25
CGH	VCF 12/23	380-415	3 phase + N	11.5
CGH	VST 12/900	200-240	3 phase delta	15
CGH	VST 12/900	220-240	single phase	22
CGH	VST 12/900	380-415	3 phase + N	8.4

Model	Description	up to	Page
A			
AAF	Standard Ashing Furnaces	1200°C	49
AAF-BAL	Ashing Furnace with Balance	1100°C	51
ABA	Asphalt Binder Analyser	750°C	96
ABF	Afterburner Ashing Furnaces	800°C	53
AX	Laboratory Bench Mounted Ovens	250°C	13
AZ	8-Zone Tube Furnaces	1350°C	89
B			
BLF	High Temperature Bottom Loading Furnaces	1800°C	36
BWF	now renamed CWF-B	1200°C	30
C			
CDF	Dental Furnaces	1530°C	99
CF	Cupellation Furnaces	1200°C	100
CR	Clean Room Ovens	250°C	23
CTF	Large Tube Furnaces	1200°C	59
CWF	Standard Chamber Furnaces	1300°C	30
CWF-B	Burn-off Chamber Furnaces	1200°C	30
CWF-BAL	Chamber Furnaces with Balance	1100°C	30
E			
EHA	Horizontal Compact Tube Furnaces	1200°C	60
EHC	3-Zone Horizontal Compact Tube Furnaces	1200°C	60
ELF	Economy Chamber Furnaces	1100°C	29
EST	Horizontal Compact Split Tube Furnaces	1200°C	74
EVA	Vertical Compact Tube Furnaces	1200°C	60
EVC	3-Zone Vertical Compact Tube Furnaces	1200°C	60
EVT	Vertical Compact Split Tube Furnaces	1200°C	74
EVZ	3-Zone Vertical Compact Split Tube Furnaces	1200°C	74
EZS	3-Zone Horizontal Compact Split Tube Furnaces	1200°C	74
EZS-3G	Compact Gradient Split Tube Furnance	1200°C	91
F			
FHA	Horizontal and Vertical Tube Furnaces	1350°C	64
FHC	3-Zone Horizontal and Vertical Tube Furnaces	1350°C	64
FST	Horizontal and Vertical Split Tube Furnaces	1300°C	82
FZS	3-Zone Horizontal and Vertical Split Tube Furnaces	1300°C	82
G			
GHA	Modular Horizontal Tube Furnaces	1200°C	62
GHC	3-Zone Modular Horizontal Tube Furnaces	1200°C	62
GLO	Annealing Furnaces	1100°C	46
GP	General Purpose Ovens	300°C	17
GPC	General Purpose Chamber Furnaces	1300°C	39
GPCMA	Modified Atmosphere Chamber Furnaces	1200°C	40
GSM	Specialist Ashing Furnaces	1100°C	52
GVA	Modular Vertical Tube Furnaces	1200°C	62
GVC	3-Zone Modular Vertical Tube Furnaces	1200°C	62
H			
HB	Top Hat Furnaces	1800°C	43
HRF	Air Recirculating Furnaces	750°C	45

Model	Description	up to	Page
HST	Horizontal Split Tube Furnaces	1200°C	76
HT	High Temperature Industrial Ovens	600°C	19
HTCR	High Temperature Clean Room Ovens	600°C	24
HTF	High Temperature Laboratory Chamber Furnaces	1800°C	37
HTF	High Temperature Industrial Chamber Furnaces	1800°C	38
HTMA	High Temperature Modified Atmosphere Ovens	700°C	22
HTR	Rotary Reactor Tube Furnaces	1100°C	86
HTRH	High Temperature Horizontal Tube Furnaces	1800°C	68
HTRH-3	3-Zone High Temperature Horizontal Tube Furnaces	1800°C	68
HTRH-GR	Graphite Tube Furnaces	2600°C	72
HTRV	High Temperature Vertical Tube Furnaces	1800°C	70
HTRV-A	High Temperature Vertical Split Tube Furnaces	1700°C	84
HZS	Horizontal Split Tube Furnaces	1200°C	76
HZS-2G	Compact Gradient Split Tube Furnance	1200°C	90
K			
KST	Large Horizontal Split Tube Furnaces	1200°C	80
KVZ	3-Zone Large Vertical Split Tube Furnaces	1200°C	80
KVT	Large Vertical Split Tube Furnaces	1200°C	80
KZS	3-Zone Large Horizontal Split Tube Furnaces	1200°C	80
L			
LCF	Large Chamber Furnaces	1400°C	42
LGP	Large General Purpose Ovens	700°C	20
LHT	High Temperature Bench Mounted Ovens	600°C	16
M			
MTF	Small Tube Furnaces	1200°C	58
MTT	Carbon-14 and Tritium Furnaces	1200°C	98
P			
PF	Fan Convection Ovens	300°C	15
PN	Natural Convection Ovens	300°C	14
PTC	Thermocouple Calibration Furnaces	1200°C	97
R			
RHF	High Temperature Chamber Furnaces	1600°C	34
RHST	3-Zone Rotating Horizontal Split Tube Furnace	1150°C	87
RHZS	Rotating Horizontal Split Tube Furnaces	1150°C	87
RWF	Rapid Heating Chamber Furnaces	1200°C	32
S			
SBCF	Static or Bogie Hearth Chamber Furnaces	1100°C	44
SCF	Smelting Furnaces	1350°C	101
STF	High Temperature Tube Furnaces	1600°C	66
T			
TLD	Rapid Cooling Ovens	400°C	18
TVS	3-Zone Vertical Split Tube Furnaces	1200°C	78
TZF	3-Zone Large Tube Furnaces	1200°C	59
TZF	3-Zone High Temperature Tube Furnaces	1600°C	66
V			
VCF	Top Loading Chamber Furnaces	1200°C	33
VST	Vertical Split Tube Furnaces	1200°C	78

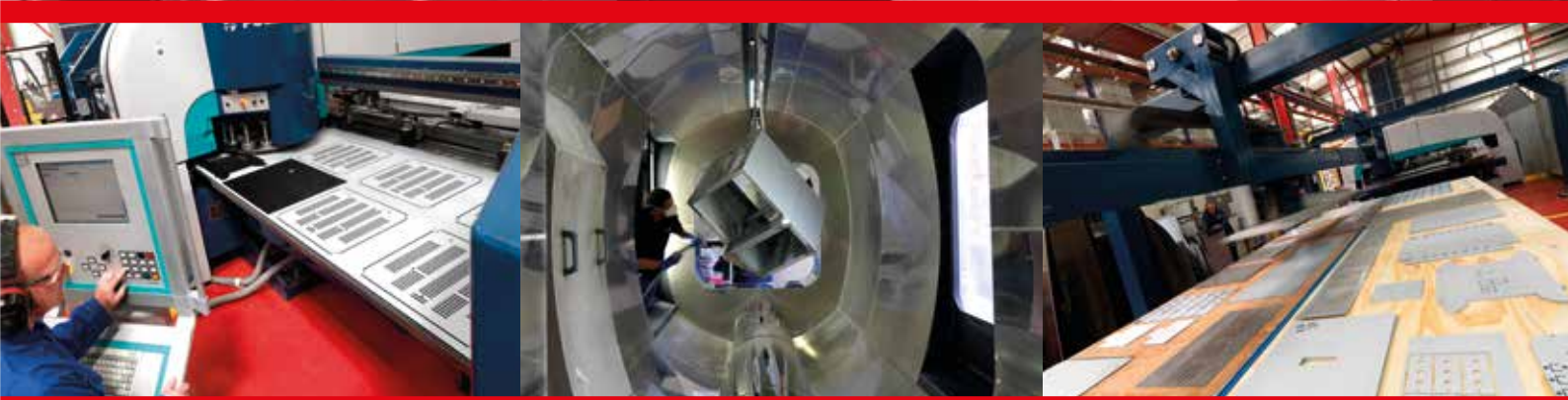

Sign up for our newsletter!

You will occasionally receive **exclusive information** on seminars/webinars, applications and product news.

Subscribe now:



www.carbolite-gero.com/newsletter
(You may unsubscribe any time)

